

BME

BROADCAST MANAGEMENT/ENGINEERING

INDIANA UNIV LIBRARY
SERIALS DEPT
BLOOMINGTON
AD
IN 47401



**TAPE
OR FILM?
HOW TO
TAKE AIM.**

Teledyne announces the introduction of their new Color Telefilm Recorder that transfers color tape to color film with remarkable quality.



Teledyne Camera Systems' CTR-2 Color Telefilm Recorder

Extraordinary quality and practical economy from the outset.

Teledyne has developed the first broadcast quality Color Telefilm Recorder. They knew that excellence was mandatory. A piece of equipment that wouldn't deliver sharp, clear, color-balanced 16mm film transfers would not stand up to your criteria. So, the system was perfected and then it was introduced.

Engineering bottom line.

Primary heart of the system is the camera (DBM-64B) which uses compressed air to pull down and stabilize the film in less time than the television vertical blanking period. Result is full

frame recording without mid-field splice or shutter bar.

System works for operator not the other way around.

Human engineering, ease of operation, and maintenance maximizes productivity. All components are immediately accessible. Test points on the printed circuit cards used with the built-in waveform monitor allow operation, adjustment, and trouble shooting without a separate oscilloscope. Slanted camera optical path is very convenient for magazine loading.

It almost had to be Teledyne.

You expect innovation from pioneers. Because the camera came first, from Teledyne, the system's development was only an extension. That camera revolutionized tape to film transfer and is clearly the industry's standard.

Partial list of nomenclature that makes the point.

DBM-64B Camera. Conrac RHM-19 Display. Tektronix 528 Waveform Monitor. Modified Tektronix 602 "X-Y" Display. CBS Labs Mark II Image Enhancer. Rank Decoder. Maurer "F" Prime or Auricon "Modulite" Variable Area Recording Galvanometers. Teledyne CK-120 Magnetic Recording System. And so on.

Giant step for the state of the art.

Video tape production and 16mm broadcast and dupe transmission are now a quality reality. To learn more about this capability and making it available to your operation, contact Teledyne Camera Systems at 131 North Fifth Avenue in Arcadia, California 91006. Telephone (213) 359-6691. They'll send you a reel sample.

 **TELEDYNE CAMERA SYSTEMS**

2-13-74

Indiana University
JAN 19 1973
Library

Now you can save more than 50% on broadcast-quality color video program control equipment.



VS-150A VIDEO SWITCHER-FADER

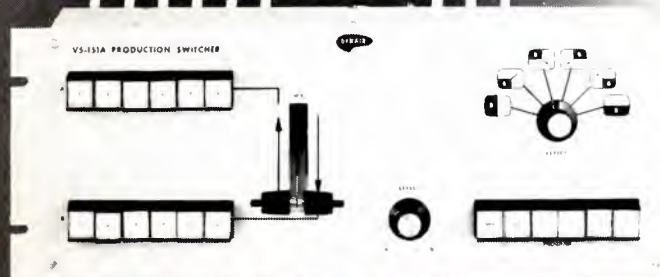

VS-151A PRODUCTION SWITCHER

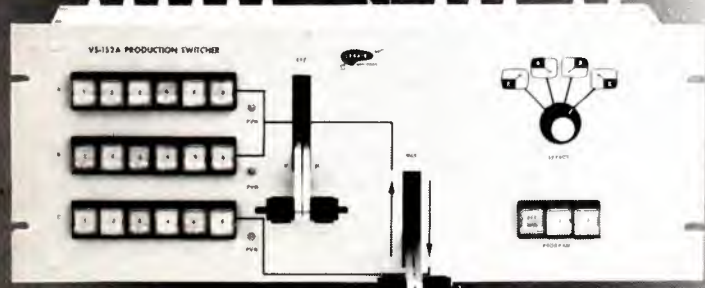

VS-152A PRODUCTION SWITCHER

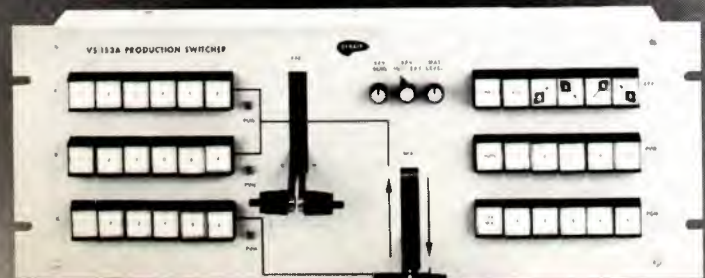

VS-153A PRODUCTION SWITCHER

No . . . we're *not* having a sale. Our building didn't burn down and we haven't lost our lease. But you *can* save more than 50 percent when you buy DYNAIR Series-150 vertical interval program control equipment.

How? You'll find out quickly when you check the prices of comparable equipment of other manufacturers. For the same capability, you will pay from two to three times as much. And you probably won't get the quality and reliability of DYNAIR equipment.

On DYNAIR program switchers you won't find cheap, troublesome sliding fader potentiometers; we use quality gear-driven, locking split-lever controls. Nor will you find other inexpensive and unreliable components. The 150 Series uses the latest silicon solid-state devices available — over 80 percent of which are in integrated-circuit form — the same quality components and temperature-compensated circuitry used in our broadcast and aerospace equipment. Fully color delay compensated too.

And . . . one of the four units will usually fit your application *and* your budget. From a \$795 basic 5-input self-contained switcher-fader to a \$2895 11-input remotely controlled production switcher with special effects . . . that's the 150-Series.

Write today for literature and prices and we'll also send a free copy of our 12-page paper "Facts About Low Budget Video Switching and Effects." It contains a wealth of useful information about selecting programming equipment for a small studio.

DYNAIR ELECTRONICS, INC.
6360 FEDERAL BLVD., SAN DIEGO, CALIF. 92114
PHONE: (714) 582-9211



Circle 101 on Reader Service Card

BROADCAST INDUSTRY NEWS

Contracts With Activist Groups Declared Broadcasters' Cop-Out

The current practice of gaining concessions and commitments of money for certain type programming and expenses from broadcasters in return for agreements to drop objections to license renewal is a violation of the FCC's 1960 Statement of Program Policy and should not be condoned, former FCC Commissioner Fred Ford told the Texas Association of Broadcasters recently.

The fact that many of the objecting groups are motivated by the very highest ideals does not justify the methods. In Ford's view, obligations imposed by the FCC on licensed broadcasters are being transferred to private groups interested in particular type programs. When broadcasters submit to such pres-

ures, they abdicate programming responsibility.

Proper policy, according to Ford, calls for referring challenges "back to the broadcaster for a more detailed showing of the ascertainment of problems or needs, evaluation thereof, and designing programs to meet them." This procedure would preserve the program authority and responsibility of broadcasters and permit the Commission "in many cases" to more expeditiously dispose of the objections under the demurrer procedures.

Other Ford recommendations: arbitrary limitation of access by local stations to network prime time should be repealed (it's in conflict with the basic responsibility of the broadcaster); the fairness doctrine should be transferred out of Section 315 dealing with equal time and the doctrine should not be extended to

any product, as distinguished from ideas, without specific Congressional direction.

TPT Grant Aids Cable Program at Univ. of Oregon

TelePrompTer Corporation has given \$5000 to the University of Oregon's Division of Broadcast Services and Televised Instruction to help maintain an award-winning program series for cable that was threatened by a University budget cut. The educational programs called "Television PL-3," which won an NCTA program award in 1970, have been carried by the local TPT cable system for seven years. The money will go for services, supplies, and student wages.

MSI Supplies Unit for Multichannel Datacasting

A new cable TV electronic device, developed by MSI Television and called Multi-Channel Datacasting will put on the cable three separate color programs originated in a single character-generator chassis. The first unit, installed at Waco Cablevision, Waco, Texas, sends out on Channel 9 a full data weather service, including the NOAA weather wire from the U. S. National Service. The same channel presents local messages and news, along with color slide advertising. The two additional channels, 4 and 5, present daily program guides when non-duplication rules cut programs from those channels.

Hartford School Radio Station Authorized by FCC

Said to be the first high school radio broadcast station, a 10-watt FM system has been approved by the FCC for construction at the Weaver High School in Hartford, Conn. The station is a joint project of the Aetna Life and Casualty Insurance Co., which is financing construction; of station WTIC, which will give technical expertise; and of the school administration. It will be

continued on page 8



Magnetic Disc Video Recorder Will Act As "Slide" Projector in TV Film Chains

A new form of video recorder, using an instantly interchangeable flat magnetic disc of flexible material to store up to 300 fully interlaced, full-resolution still frames, has been put on the market by Arvin Systems, Inc. of Dayton, Ohio. Called the "Discassette Recorder," the unit loads in less than 10 seconds by insertion of the flat disc into a slot. The maker claims a 4.2 MHz bandwidth, 40 dB S/N ratio, and time base error of less than 400 nanoseconds, for full professional image quality. The recorded images can be projected onto an associated monitor and fed to a video console at selectable rates of 1, 3, 6, 10 or 15 frames per second. Cueing of individual frames or sequences is readily accomplished. For the television broadcaster, the maker sees the unit as easier and faster to use than a conventional slide film chain or camera graphics. It can also be used to store images to be inserted in a VTR program, making them quickly available to the tape editor. Color version is not yet available.

MULTI-WIRE TOTAL PLATE VOLTAGE FINAL PLATE CURRENT POWER INDICATOR
SPARTA
 MODEL 602 FM TRANSMITTER

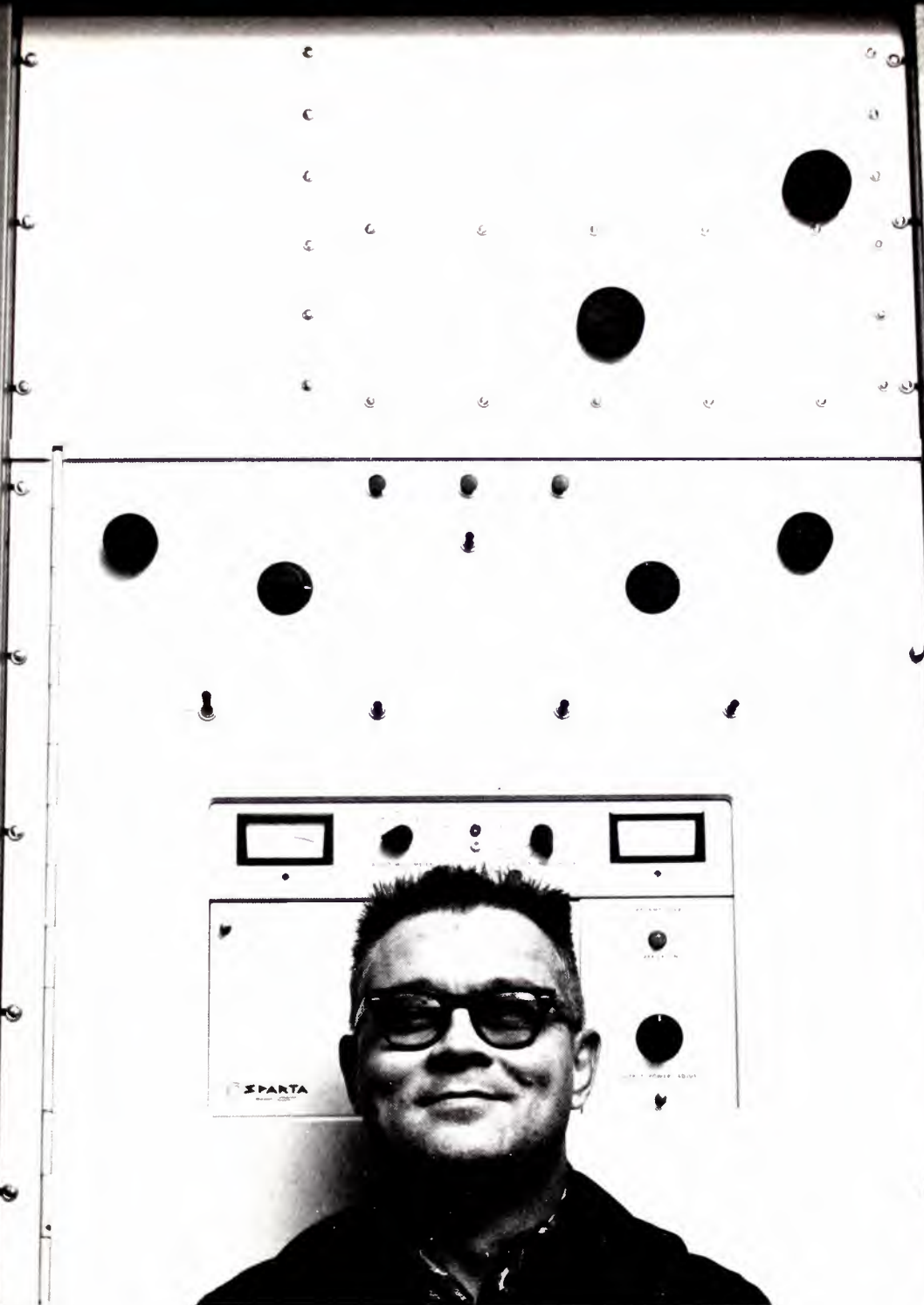

Quality and Service make Sparta 'just right'

Harry C. Snyder grew up with KHUB, Fremont, Nebraska. He became its C.E. at 16, owner at 29. Harry's experience with KHUB's Sparta 701 AM transmitter convinced him that a Sparta 602 FM transmitter would be a *just right* investment also. But more than QUALITY made the difference. Ask Harry about Sparta SERVICE. The quick response, the helpful attitude, and that personal interest Sparta always has in the well-being of its friends and their equipment.

SPARTA . . . small enough to be a first name friend . . . big enough to offer EVERYTHING. The *just right company*.
 Call us. Collect.

SPARTA ELECTRONIC CORPORATION

5851 FLORIN-PERKINS ROAD SACRAMENTO, CALIFORNIA
 (916) 383-5353 TELEX 377-488 CABLE SPARTA
 A DIVISION OF COMPUTER EQUIPMENT CORPORATION

www.americanradiohistory.com

Circle 103 on Reader Service Card

staffed by students under direction of a professional manager, and will present news, interviews, popular music, sports, etc. Students will be offered courses in announcing, station operating, script writing, etc.

FCC Affirms Equal-Hiring Rule for Religious Broadcaster

The Federal Communications Commission has affirmed that the rules on equal employment opportunity apply to a broadcast station operated by a religious organization—KGDN and KBIQ-FM of King's Garden, Inc., Edmonds, Wash. The licensee had contended that recent amendments to the Civil Rights Act made them exempt from the rules on religious discrimination in hiring. Not so, said the FCC: obtaining a broadcast license imposes on the licensee all the obligations to the public which go with it. The stations were ordered to submit a complete account of their future hiring practices and their policy on giving air time to other religious views.

WBTV, Charlotte, Will Light Tower as "Christmas Tree"

For the third year, WBTV in Charlotte, N.C., has put more than a thousand colored lights on their one-thousand foot antenna tower, to make a "Christmas tree" visible for many miles in the area. The light-up was televised on December 4. The "tree" can be seen, for example, by airline pilots minutes after they take off from Atlanta, Georgia.

Southern CTA Will Meet In April in Mobile

The Southern Cable Television Association has set April 1-3, 1973 for its annual meeting, and the place is Mobile, Alabama. Meeting hall will be the Mobile Municipal Auditorium. Details: SCTA, 383 Pine Forest Drive, Lawrenceville, Ga., 30245.

Church Group Offers Guide To License Renewal Procedures

The redoubtable Office of Communication of the United Church of Christ has prepared what is in effect a battle manual for groups seeking to influence broadcast station practices. Titled "Guide To Understand-

ing Broadcast License Renewal Applications and Other FCC Forms," the pamphlet outlines the renewal process, tells about the broadcaster's programming and equal employment responsibilities, and shows examples of the FCC forms. The purpose of the guide, according to Dr. Ralph M. Jennings who prepared it, is to help citizen groups evaluate proposals for service made by broadcasters.

Survey of News and Magazine Writers Finds Most Taping "Notes"

The Certron Corporation, tape equipment maker of Anaheim, Calif., announced that a survey of writers for leading magazines and newspapers found almost all using cassette recorders for on-the-spot notes, interviews, even for recording night-club and music shows up for review. Writers for scores of national publications answered the survey questions, including Esquire, Cavalier, the New York Times, the New York Post, Variety, Penthouse, United Features Syndicate, etc.

Three Groups Say Working Women See More TV Ads Than Any Other

Three industry organizations—The Bureau of Advertising, the Radio Advertising Bureau, and the Television Bureau—have completed separate studies all of which indicate that working women spend more time with television than with any other advertising medium. The TV time per day varied somewhat among the three studies, but all put TV first. The full story is in a new TvB report, "What Two Things Did 30,000,000 Women Do Yesterday That Affect Your Business?" Copies: TvB, One Rockefeller Plaza, New York 10020.

Anaconda Buys Systems Wire and Cable

Anaconda and Systems Wire and Cable have agreed in principle on the acquisition by Anaconda of Systems, according to an announcement made at the California Cable TV convention in November. Systems will be an operating unit of Anaconda Electronics, the CATV division of Anaconda. Key operating personnel of Systems will remain, and the Systems' plants at Phoenix, Arizona, and Rome, New York, are to be retained and expanded.

Communications Library Offers Cable Series on Law in Spanish

Communications Library of San Francisco has prepared a ten-part series of program formats for cable origination, "Asi Es Neustra Ley," which guides the production of programs explaining the local law in any city or town to Spanish-speaking audiences. The programs allow for local participation, and are adapted to direction by a community group, lawyer, or cable program personnel.

Trans-World Shows Converter For Four Pay-Cable Channels

Trans-World Communications, the closed-circuit division of Columbia Pictures Industries, Inc., in cooperation with Oak Industries, Inc., International Video Corporation, and the K'SON Corporation, introduced in November a pay-cable system with a special set-top converter that allows any cable operator to send out up to four channels of pay-TV programming, and provides 22 other off-air and local origination channels.

Elements of the system include an origination console built by IVC and using the IVC one-inch videotape system; digital control equipment built by K'SON Corp; and a program selector incorporating the Oak Gamut 26 converter.

Avoid Sex Sensationalism Says NAB Radio Code Board

The Radio Code Board of the National Association of Broadcasters passed a unanimous resolution calling on radio broadcasters to handle talk about sex with great care. Some recent broadcasts, said the NAB, have aroused concern because of the very free way that sex has been presented. "Sex discussions should be responsibly handled so as to avoid sensationalism or advice which goes counter to generally accepted medical opinion," the NAB warned.

Justice Department Wrong on Program License Time Limit Says NAB

The Justice Department has "misstated the law and misconceived the facts" in recommending a time limit on exclusive licenses for non-network programs, the National Association of Broadcasters said in comments filed with the FCC. Ex-
continued on page 10

Shibaden video cameras...

show it like it is



Simulated TV Picture

Indoors or out. Shibaden broadcast-quality color-TV cameras "see" what the eye sees. They capture all the true color, all the sharpness, all the fidelity.

Take the Shibaden FPC-1000A, pictured above. This stable, simple-to-operate color camera combines top performance with top value. Its three vidicons provide superior sensitivity. It meets critical performance standards and offers all the features you expect in a quality broadcast camera (and more than you'd expect at one at this price!).

Other Shibaden color cameras about which you may want to learn more are, left-to-right, below: FPC-1000H. Broadcast version of the 1000A with additional features, including a built-in I and Q encoder. The HV-1100 is ideal

for video-microscopy and fiber-optic interface, and is lightweight (17½ lbs.). Then comes the excellent, top-performing Shibaden FP-1200 three-tube Plumbicon* studio camera. It obsoletes others in its class.

Add monochrome cameras, color and monochrome VTRs, monitors, lenses, and the rest of the 150-product Shibaden line . . . you'll begin to see why we think Shibaden will do wonders for your image.

SHIBADEN CORPORATION OF AMERICA

Exec. Off. · 58-25 Brooklyn-Queens Exp'y, Woodside, N.Y. 11377
21015-21023 S. Figueroa St., Carson, Calif. 90745
1725 No. 33rd Ave., Melrose Park, Ill. 60160
100 Martin Ross Ave., Downsview, Ontario, Canada



THE WORLD'S FINEST



Antenna

TEST SITE

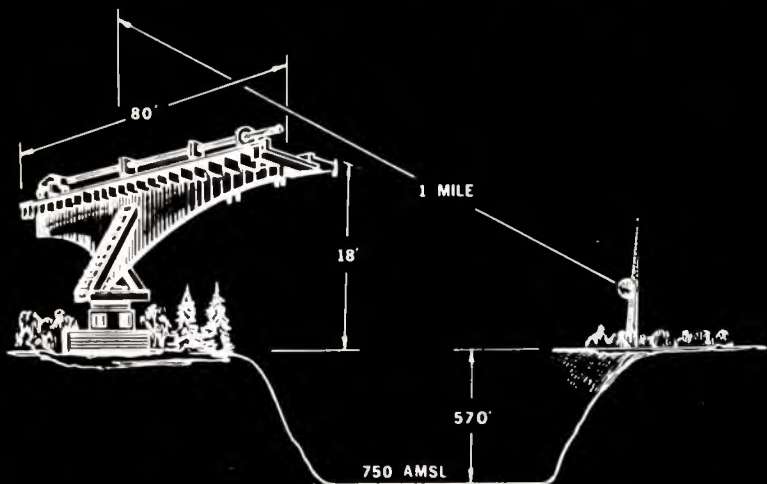

CCA RF Industries offers you a one mile long test site with an 80 foot long rotatable platform for evaluating VHF and UHF TV antennas.

You are assured that the CCA TV antennas will provide you coverage where it is desired.

You are cordially invited to visit this site.

CCA RF INDUSTRIES, INC.

P. O. BOX 315

WESTFIELD, MASS. 01085

A Subsidiary of

CCA ELECTRONICS CORPORATION
716 JERSEY AVENUE, GLOUCESTER CITY, N. J. 08030

Circle 106 on Reader Service Card

NEWS

clusivity practices, said NAB, are "critically necessary to successful programming" and a fixed rule setting a time limit on exclusivity "would be contrary to the interests of all concerned, including the public." The NAB said there is no evidence of "warehousing," licensing material to keep it off the markets; present licensing practices have had no anti-competitive effect.

Com-Plex Is New Canadian Firm in Cable Business

Formerly Vikoa of Canada, Ltd., a new firm, Com-Plex Electronics, Ltd., will serve the Canadian cable industry with a broad line of equipment and increased field services. General manager is David A. Shefler; head office is at 5215 de la Savane, Montreal.

New Microwave Relay System For Midwest TV Networking

Midwestern Relay Company, a common-carrier operation based in Wisconsin and Michigan, is in the advance stages of installing equipment to connect ABC, NBC, and CBS affiliates in the area to Chicago headquarters for distribution of television programs. The equipment has been supplied by the Raytheon Company. Stations in Milwaukee, Madison, and Green Bay will be served initially, with later extension of the service to Duluth, Minneapolis and St. Paul, Minn., and Wausau, Wis. The company has also been authorized by the FCC to start construction on a microwave system down the Mississippi River Valley from Minneapolis to Rochester and Austin, Minn., and Waterloo, Iowa. The company is a joint venture of the Milwaukee Journal and American Microwave and Communications, Inc., of Iron Mountain, Michigan. The latter firm already has an extensive microwave plant in Michigan, serving broadcast stations and CATV systems.

TV Main Source of Data on Pollution, TIO Study Finds

A nationwide study by R. H. Bruskin Associates for the Television Information Office has shown that most people get their information about water and air pollution and consumer protection from television. Conducted in September, the study showed 57% of respondents

continued on page 12

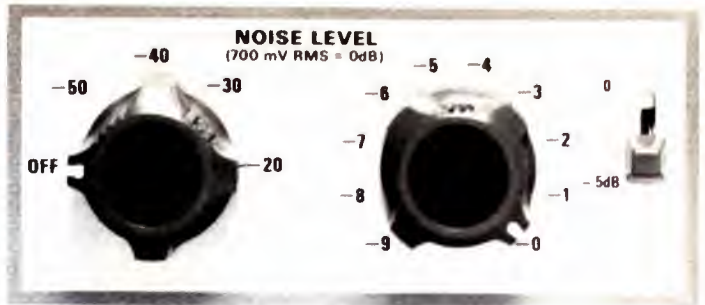

easy

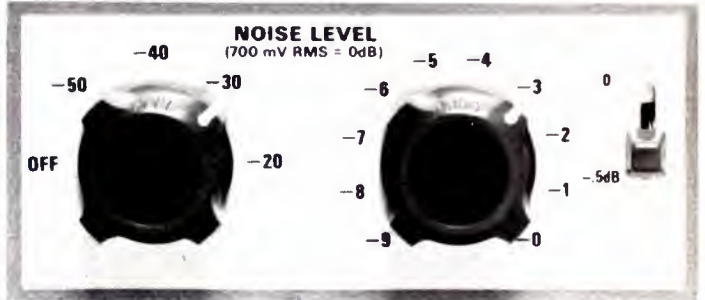

in-service

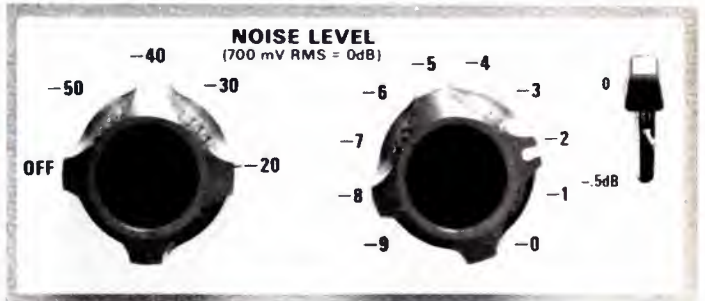

noise measurement



the TEKTRONIX 1430

It's easy to make in-service or out-of-service noise measurements with the TEKTRONIX 1430 Random Noise Measuring Set. An error-free, side-by-side comparison technique is used. A portion of a line is deleted and a calibrated noise level is then inserted by the TEKTRONIX 1430. The noise level to be measured and the 1430's calibrated noise output are then matched side-by-side on a waveform monitor or scope. This method is highly accurate. In-service noise measurements, using a

selected line in the vertical interval, are made with better than 2-dB accuracy. And the measurements are meaningful in terms of what you see on a picture tube because CCIR weighting and low-pass filters are built in.

Accurate, repeatable measurements are convenient to make in cameras, VTR's, STL's transmission systems or wherever video-frequency random-noise is a problem. Of course program material is protected with copper-to-copper safety. Tests

can even be performed in the absence of composite sync using the 1430 generated horizontal sync. Full-field measurements can be made with resolution approaching 0.5 dB. For more information about the Tektronix noise measurement technique, contact us at P.O. Box 500-A, Beaverton, Oregon 97005.



in Europe —
TEKTRONIX LTD.
Guernsey, C.I., U.K.

TEKTRONIX®

committed to
technical excellence

Circle 107 on Reader Service Card

For demonstration:
www.americanradiohistory.com

Dear Gabby:

"How can a wife compete with a \$10,000 Video Tape Editing System featuring Jam-Sync?"



Datatron's Girl Gabby

DEAR GABBY: My husband returned from the NAB show singing the praises of a \$10,000 Video Tape Editing System which features something called 'Jam-Sync'. Since he seldom praises my homemade jams, or notices the hours I slave over the kitchen sink, I need help in winning him back.

NEGLECTED

DEAR NEGLECTED: Many NAB visitors fell in love with Datatron's Model 5050 - a Video Tape Editing System with keyboard entry which works with helical or quadruplex VTRs, yet is priced at \$10,000, thousands under competition. In fact, a number of TV stations placed orders right at the show.

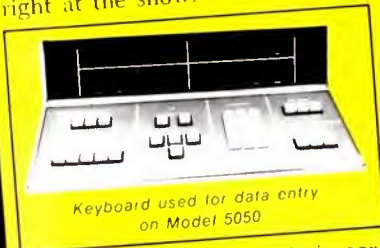

Keyboard used for data entry on Model 5050

The jam-sync feature is important since it eliminates the need to pre-record the SMPTE time code on tapes for add-on editing from masters or live sources.

Instead, during pre-roll, the built-in time code generator is set & sync'd so that time picks up exactly where it left off - to the

frame! This saves hours of time, and head wear on expensive video recorders too.

But don't fret. Once your husband's Datatron Model 5050 is installed, he'll have more free time to sing the praises of your jams and jellies.

GABBY

★ ★ ★

DEAR GABBY: How can Datatron sell a SMPTE edit code reader for \$1500 and a generator for \$1750 when competitive models go for over \$2500?

AFRAID OF BARGAINS

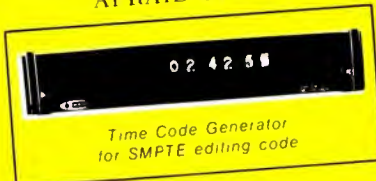

Time Code Generator for SMPTE editing code

DEAR AFRAID: Don't be afraid of these bargains. Datatron's edit code reader & generator are fallouts from their Video Tape Editing System project. The low prices reflect simple construction and dedicated design. Actually, they cost less than capstan revolution counters which aren't nearly as accurate.

GABBY

★ ★ ★

Send your questions - either straight or humorous - to Gabby. We'll mail a Flair pen for all received and pay \$100 if we use question in future ad.

datatron inc.

1562 Reynolds Ave / Santa Ana, Calif. 92711
(714) 540-9330

moving up fast in...



Automatic Test Systems



Microelectronic Testing



Timing Instrumentation



Shelly Indicators and Readouts

NEWS

putting television first for pollution data, with newspapers named by 29%. On consumer protection, 50% put television at the top, 28% said newspapers. Television was ahead for all levels of education and income, although there were variations in the figures, the TIO announced.

Slight Color Drop Doubles Life of Background Lamp

A new tungsten halogen 1500-watt studio lamp for background use, the T20 DSF from GTE Sylvania, has a rated life of 500 hours, compared with 250 hours for an earlier T20. Major difference between the two is a drop in color temperature of 50°, from the 3200°K of the older version to the 3150°K of the new one.

Business Briefs

Pay Television Corporation has agreed with **Kaiser Broadcasting** to buy the latter's UHF KBSC-TV in Los Angeles, with the intention of converting the station to use the Phonevision pay system developed by Zenith. . . . The cable operations of **GTE Sylvania** went from Seneca Falls, N.Y., to new headquarters at 114 S. Oregon Street, El Paso, Texas. . . . **TelePro Industries** reported sales for the nine months ended September 30, 1972 at \$4,913,290 and profits at \$109,655, up from \$3,467,853 and \$59,420 in 1971.

The first local independent radio stations authorized in England by the Independent Broadcasting Authority will use **Marconi** transmitting equipment. . . . **Ameco, Inc.** is supplying equipment for a Metro-Com cable system in Mt. Wolf, Manchester Township, and York Haven, Penna. . . . Employees of **B. F. Goodrich** are enrolled in college courses televised to plant locations by **Instructional Television Network**, an operation of Case Western Reserve University in Cleveland, which is distributing courses via TV to a number of companies in the area. WXIX-TV, Miami, Ohio, reported that station personnel during October represented the station 39 times in community affairs. . . . **AEL Communications Corp.** has sold equipment and will install and give proof of performance for about 600 miles of cable system in Mexico for **Cablevision S.A.**

Electronic Engineering Company has appointed **Telemet**, Amityville,

continued on page 48

OUR NEW VIDEO TAPE DEPARTMENT IS NOW OPERATIONAL FOR:

tape to tape, film to tape and tape to film transfers

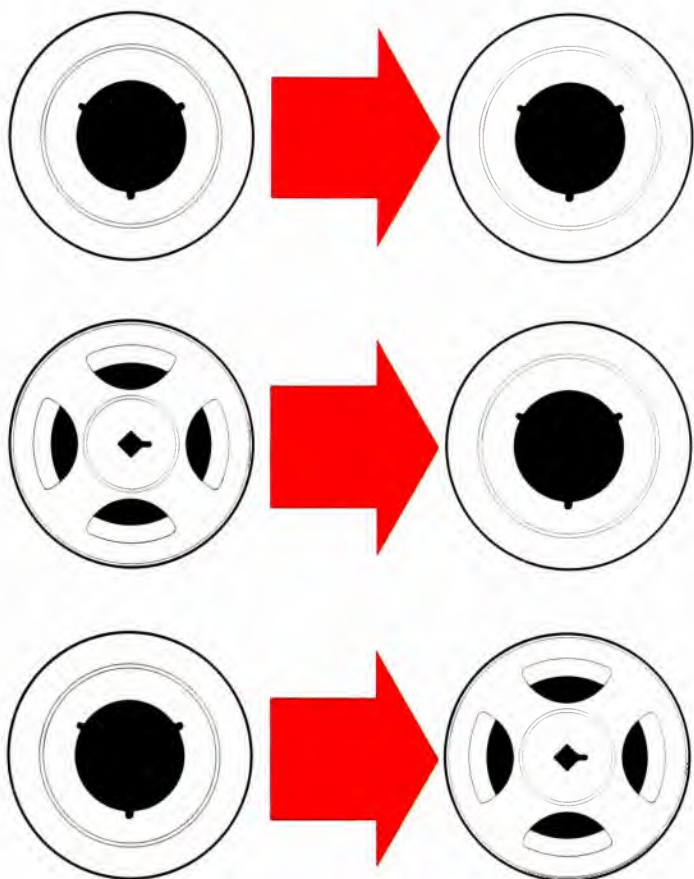

OUR MOST MODERN HIGH-SPEED DUPLICATING EQUIPMENT WILL PRODUCE 3 COPIES OF A 60-MINUTE PROGRAM IN 6 MINUTES FLAT . . . WHICH TRANSLATES INTO FASTER DELIVERY AND BIGGER SAVINGS TO VIDEO TAPE PRINT BUYERS.

VIDEO FACILITIES:

- Small Studio With Lights—
 - Two Norelco PC100 Color Studio Cameras
 - Video Viewing Room.
 - 2 Ampex AVR-1 Video Recorders.
 - 1 Ampex VTR-2000 Video Recorder.
 - 3 Ampex 1" 7800 Video Recorders.
 - 1 IVC 1" Video Recorder.
 - 1 Sony 1/2" Video Recorder.
 - 1 Sony 1" Video Recorder.
 - Ampex AVR-1 Editor.
 - Editing Program Computer.
 - Norelco Telecine Chain.
 - Norelco Audio Console.
 - Grass Valley Double Re-entry Effects Switcher.
 - Electron Beam Recorder.
 - Vidtronics Video Color Film Recorder.
 - Ampex Tape High-Speed Duplicator.
 - CBS Color Corrector—
 - Sony 3/4" Videocassette Duplicator.
- And Much, Much More.*

byron COLOR-CORRECT[®]

 **ELECTRON BEAM RECORDING
FOR BLACK AND WHITE**

65 K Street, Northeast, Washington, D.C. 20002 202/783-2700

World's Most Sophisticated Video Tape and Film Laboratories

Circle 110 on Reader Service Card

JANUARY, 1973—BM/E

www.americanradiohistory.com

INTERPRETING THE **FCC** RULES & REGULATIONS

Municipal Ownership Of Cable Systems*

One of the most crucial and atomic issues facing the CATV industry today is "municipal" or "public" ownership and operation of cable systems. The propriety and practicality of any form of government ownership must be evaluated in terms of its contribution vis-a-vis private ownership. Municipal ownership is an issue of far-reaching implications, confronting not only the spirit of past pronouncements by the Federal Communications Commission but also the spirit of the U.S. Constitution.

Apparently the Commission has little jurisdiction to deal with this matter under the "deliberately structured dualism" of the cable rules. However, through its Cable Television Advisory Committee which deals with problems of federal-state/local relationships, the Commission could offer *advisory* treatment of the matter. Although the Committee focuses primarily on subjects pertaining to franchising procedures, criteria, etc. (see "Interpreting," *BM/E*, August 1972, p. 16), its role is *not* limited thereto.

I. Forms of and Arguments For Municipal or Public Ownership

"Public ownership" of cable television could take many forms. For example, it could be: 1) ownership by one or many nonprofit organizations (similar to ETV); or it could be 2) *de facto* public ownership via dedication of many or all of the unused channels to "the public" (as was proposed last year in the Florida State legislature); each *de facto* public ownership might be characterized, in FCC vernacular, as "common carrier status;" or it could be 3) direct ownership by the local government (municipal, county or state). It is difficult to discuss one form without alluding to the others. Their *effects* on the public are apt to be similar.

Proponents of these forms of CATV ownership generally view their advantages to the public, as follows:

- 1) They foresee such ownership generating tremendous financial resources for the municipality;
- 2) They reason that a system's profits should be directly applied to such public uses as educational and community programming;
- 3) They believe such ownership will force a cable system to be more directly responsive to public policy considerations.

While these public-benefit objectives are univer-

* This month's commentary departs from *BM/E*'s usual perspective in that it is not strictly an interpretation of FCC rules and regulations. It takes an advocacy position against municipal ownership drawing from a larger framework than FCC rules: namely, the U. S. Constitution.

¹The term: "public ownership" as used herein does not refer to those companies that offer their stock for public sale. The term herein is confined to *de jure* or *de facto* ownership by local governments or nonprofit organizations.

sally laudable, the method or ownership-vehicle for best implementing such advantages is a matter of considerable controversy. As such, one must contemplate all issues raised by municipal ownership—political, technical, economic, and financial.

II. Arguments Against Municipal or Public Ownership

A. Resources for the Municipality?

The interest some public officials show in municipal ownership of CATV is largely a product of the much-publicized financial crisis at all levels of government. However, the concept of municipally-owned CATV as a money-mill for the local government is chimerical. Not only is there too much risk involved, but the local government would be much less likely than private entrepreneurs to make the experiments necessary for CATV to reach its maximum potential.

From an economic standpoint, a municipality flirts with financial disaster when it assumes that a major-market CATV will generate enormous, or even any, profits. Local governments fail to comprehend, and even ignore, the incredible unknowns of the new generation of CATV. Capital cost, for municipally-owned systems, are likely to be underestimated. Furthermore, *the city will lose the tax base and revenues it could have derived from private ownership.* The very business of CATV necessitates speculation and high economic risk. Cost overruns can spell disaster not only to the public treasury, but also to local programming, the pearl of the art that distinguishes CATV from its rival medium—broadcast television.

B. System's Profits Applied to Community Programming?

To date, some 18 cable systems in the U.S. (principally small communities) are municipally owned. *Not one of these originates its own programming.* Indeed, some have filed for waiver of the Commission's rules on local originations. Each exists as a passive reception system for broadcast services, its revenue a hidden tax on the public. Also, from a technical standpoint, it is evident that CATV is still in its infancy. Which sector (public or private) is most likely to operate in the public interest—to inspire new cable technology, to gamble large sums on high-risk new services, and to absorb the large losses that must follow CATV from its present infancy through its youth, adolescence and early adulthood? It simply does not square with past experience to imagine any government body daring and innovative enough to purchase and experiment with exciting, unproven gear that would best serve the public. It

continued on page 16

New in our book...

A fine Compact Production Switcher from COHU



Cohu introduces a totally new Compact Production Video Switcher, designed for the small studio. All electronics are housed in less than one cubic foot of space under a 19" x 10.5" panel. This switcher offers you features found only in a larger, more expensive unit.

- Additive or non-additive mixing, selected by a front panel switch. Sync is held constant through the dissolve.

- Mix, effects, inserts, dissolve to inserts or effects, wipe key, external keying and self-keying are standard modes of operation. The video flow path permits fading of titles and special effects.

- Audio-follow-video logic allows only one audio source to be selected at a time. In a lap dissolve or wipe, the logic follows the previous source until the operation is complete.

- Full color timing under every switching and preset condition provides high quality color through any path.

- Eight synchronous plus two non-synchronous/synchronous inputs. All synchronous inputs may be composite or non-composite. Independently programmable sync adding circuits are provided for each circuit.

- Vertical interval switching with momentary pushbutton controls. A single cut button can transfer preview bus to program bus.

- Matte generator provides any shade of gray or one preselected color with variable luminance and permits matting in the self-key mode.

- All mix/effects can be previewed.
- Pushbuttons are softly illuminated for operation in subdued light. Video flow paths have easy to see path indicator lights.

One low price brings you the complete switcher with all the features listed above. Now is the time to place a modern Cohu Compact Production Video Switcher in your studio.

We're meeting the demand.

BOX 623, SAN DIEGO, CALIFORNIA 92112 - PHONE 714-277-6700 - TWX 910-335-1244

COHU
ELECTRONICS, INC.
SAN DIEGO DIVISION

Circle 111 on Reader Service Card

www.americanradiohistory.com



1 Model OIB-1 Operating Impedance Bridge measures "in circuit" impedance of networks, transmission lines and antennas. Accuracy $\pm 5\%$ ± 1 Ohm. 5 kW Power rating-VSWR 3:1.



2 Model CPB-1 Common Point Bridge measures resistance to $\pm 2\%$ ± 1 Ohm and reactance to $\pm 5\%$ ± 1 Ohm at full power.



3 Model RG-1 Receiver/Generator combines a high output power signal generator with a shielded receiver for use with Model OIB-1 or any other impedance bridge.

THE DELTA TRIO

for optimum
monitoring
of your
antenna
system

With this "Delta Trio", you can either "spot check", or continuously and accurately monitor actual "on-the-air" operating impedance of transmission lines, networks and antenna systems to maintain a "clean signal" at peak operating efficiency.

If you're operating with a directional antenna, there's real value in being able to keep the radiating system in close adjustment at all times...continuously verify common point impedance to insure full power output...plus locating and correcting any antenna problems—fast!

Complete details and application data are available without obligation—just write or call **Bill Cottles**, DELTA ELECTRONICS, INC., 5534 Port Royal Road, Springfield, Va. 22151 (703) 321-9845.

DELTA ELECTRONICS



Exporter: DELTA ELECTRONICS, INC.
International Division, 154 E Boston Post RD
Mamaroneck, N. Y. 10543, Telex 1 37327, Art Rocke
Circle 112 on Reader Service Card

would not be politically prudent, considering the grave risks of tax dollars and attendant public criticism, for a group of public officials to finance and experiment with unproven two-way gear, facsimile services, pay-TV fare, in-line converters, underground construction, or digital communications. Surely CATV's growth and service to the public would more likely be inhibited than enhanced by municipal ownership.

As acknowledged, public ownership for the purpose of operating in the public interest has *some* merit. Yet, the public interest guarantees of cable ownership would be better served if such were secured at the *franchising* stage, rather than through direct or indirect municipal ownership. Many franchising authorities (e.g., Arlington, Va. and Baltimore County, Md.) have included strong public interest provisions (creation of Citizen Advisory Boards, ascertainment of community needs, etc.) in their CATV ordinances. Moreover, the newly-created Cable Television Information Center (CTIC) was established for the express purpose of guiding local authorities in developing ordinances that assure such protection.

C. The Public Interest?

The contention that public ownership of a cable system will contribute to the responsiveness of that system to the people it is designed to serve is not without merit. Citizen-participation in the choice of local programming and in the operation of a medium of such vast abundance and local influence is clearly in the public interest. Yet how does a municipality assure that such will be truly realized?

There are tremendous philosophical objections to a government-controlled cable system controlling local programming, news coverage, editorials and the like. In a democracy, the threshold questions must be faced:

1) To what extent should a local governing body control the media?

2) To what extent should a local governing body be engaged in a profit-making enterprise?

First, for many years the FCC has promulgated rules and policies that are designed to foster *maximum diversity* of the sources of public opinion. It may be dangerous indeed to assume that a *single* local government or a surrogate contractee would do more to diversify public-opinion sources than would a single private entrepreneur.

Is it not possible, if not altogether probable, that officials or councilmen, controlling, either directly or indirectly, a medium of such vast local influence, would find some method of turning it to political advantage? Would public officials be unbiased in their regulation of news dissemination and public-interest programming? Is it not likely that the controlling governmental body would influence the content of at least a portion of local originations? And is not the power of public officials to have franchise/-contract rights with a private cable operator *with an immediate right of revocation* as great a stimulus to "undue influence" and as grave a danger to "diversity," though of a somewhat different dimension, as the menace the Commission warned about in its "ownership" rulings?

continued on page 18



This green box can mean extra greenbacks.

Send for our new 12 page booklet and price list and find out how Fuji Broadcast H701 videotape can provide you with top quality performance as well as significant savings

ColTape. Home of the green box.

A DIVISION OF COLUMBIA PICTURES INDUSTRIES, INC.

COLTAPE

EXCLUSIVE DISTRIBUTORS FOR



711 Fifth Avenue Burbank Studios
New York New York 10022 4000 Warner Blvd
(212) PL 1-4400 Burbank California 91505
(212) PL 1-7859 (213) 845-8838 (213) 843-6000

Circle 113 on Reader Service Card

Now
you have a third choice
when you go
from color tape to film.



The low-priced system.
You call it "kinescope."
You like the price.
Not the quality.



The high-priced system.
You call it "expensive."
You like the quality.
Not the price.



Our new Teletype system.
You'll call it perfect.

Teletype at Mediatech is a brand new system that makes consistent broadcast quality transfers at the same cost as the low-priced system. Color or black/white. 15 or 30 frames per second. Helium free.

Give us an opportunity to prove it.

Send for our paper kit and further information.



Circle 114 on Reader Service Card

Name _____

Address _____

City _____

State _____

424 Bank Building
Park Ridge, Illinois 60068
312/433-8866

Circle 114 on Reader Service Card

FCC RULES continued from page 16

Most public officials fail to comprehend the philosophical problem that *CATV is much more than a public utility*. It is also a mass medium of communications, one with a future of unharnessed potential, and one which will be required to originate programming of its own. As a public medium, CATV is under the protection of the First Amendment. Unlike a public transit system or a traditional utility, a CATV is a *content-bearing*, not simply functional, service. Any attempt by a local government to operate the only newspaper in its area would be unlawful—in conflict with every American precept in the field. Public operation of CATV is analogous. Recent trends—the Supreme Court decision on the Pentagon papers and the refusal of the House of Representatives to cite CBS for contempt—suggest reliable philosophical precedent against government ownership. The message of these decisions is that government control of the media may lead to improper manipulation of the public. If CATV is to have status as a producer of programming, a focus for local identity and a device for exploring local needs, as it must, there is increasingly less justification for government control. *Every American tradition militates towards a separation of powers*, thereby precluding the opportunity for abuse by either of these two great estates.

Second, there is political justification for government ownership of certain public services. For example, police power is peculiarly the province of government. There are circumstances in which a service might be absolutely necessary, but only government has the resources to provide it. Many public transit systems, for example, have been taken over because government considers the service necessary, but no private investor can make a profit in it. Airlines and steamship companies receive subsidies to maintain service below actual cost.

These are painful examples of *necessary* services which can be maintained only at great public expense. Yet, there is little reason or likelihood for CATV to fall into this category. The industry is not in the kind of receivership which would justify government subsidy or takeovers. Instead, municipal ownership is often sought for the opposite reason, i.e., draining funds from CATV services for *other* purposes. Yet, if 50% of a CATV service area subscribed to the local service and the profits generated thereby were dedicated to purposes *other than* CATV (e.g., waste treatment or improved roads) for the benefit of *all* residents of the area, would this not be a form of illegal, covert tax on those subscribers?

Moreover, even if CATV is seen, as some public officials assert, as a public utility—an essential service like electricity and water and the telephone, whose availability to the public the government must insure, and whose rates and performance should be regulated—this is insufficient justification for public ownership. The American tradition, with few exceptions, has favored *private* ownership and operation of even the most necessary utilities. The post office, the police, and the fire department are the only public services universally run by government—while even "natural monopolies," like telephone service, remain in private hands. **BM/E**

Save from One Third to Two Thirds on Central Studio Background Music



You can turn your unused FM side channel into a moneymaker by offering a background music service. But why take the profit out of it by paying more than you have to...and getting less than you should? Competitive sources usually charge rates averaging 10% to 20% of your gross. Ours usually averages only 5%.

Our tapes are 100% music, not 15 minutes on, 15 minutes off. They are the highest quality tapes available, always new (we destroy old, returned tapes).

Here's how it works. The Rowe Central Studio Library initially consists of 15 six hour reels for a total of ninety hours. Every 30 days thereafter two six-hour refresher reels are sent with instructions on which reels to return and recommendations for programming. The service includes our providing Christmas music at no additional charge. It's actually less expensive than "do-it-yourself" programming.



Rowe international, inc.

A SUBSIDIARY OF TRIANGLE INDUSTRIES, INC.
75 TROY HILLS RD., WHIPPANY, N. J. 07981, TEL: (201) 887-0400, CABLE: ROVENO

FRANCHISES ARE NOW AVAILABLE
THROUGHOUT THE COUNTRY

Please send me more information about
Central Studio Background Music

CUSTOMUSIC

Rowe International, Inc.
888 Providence Highway (Rear) Dept. BM
Dedham, Massachusetts 02026

NAME _____
STREET _____
CITY _____ STATE _____ ZIP _____

Hand-Portable Remote Radio Pickup Transmitters

By Leo G. Sands

You may be able to transmit direct from the street to the studio with these hand-held units.

THE RECENT DEVELOPMENT of relatively high-power solid-state hand-held (walkie-talkie) and hand-carried (pack set) radio transceivers and scan-

Mr. Sands is a communications consultant and writer (the author of many books) and is located in New York, N.Y.

ner receivers adds to the flexibility of remote radio pickups. These relatively new transceivers are available for the low (30-50 MHz), high (150-174 MHz) and UHF (450-470 MHz) bands. Similar units for the 25-30 MHz portion of the radio spectrum are available on special order. (The remote radio pick-up channels are listed in Table 1.) These portable transceivers are available in single- and multi-channel types.

Since they are transceivers, they can be used for transmission of programs to the studio and for reception of cues. Nearly all of them are designed for voice transmission (300-3000 Hz) and are therefore unsuitable for transmission of music unless modified. They are very adequate for man-on-the-street interviews and for reporting news from the scene.

The transmitting range of a portable transceiver, rated at 1-10 watts RF output, is lower than that of a much higher powered mobile unit installed in a vehicle. But the transmitting range can often be adequate when suitable receivers and receiving antennas are used.

It is generally assumed that transmitting range at frequencies below 30 MHz is greatest. This is usually true. However, transmission in the high and UHF bands over short distances can be better because the signals are more easily reflected, particularly in the UHF band. The larger propagation losses at higher frequencies can be offset by using high gain receiving antennas.

At 150 MHz the free space transmission loss is 80 dB at a distance of one mile and 94 dB at a distance of five miles. At 450 MHz, the two figures are 90 dB and 104 dB respectively, 10 dB greater than at 150 MHz. But the noise level at 450 MHz is considerably lower, making it feasible to utilize lower-level received signals. The shadow and grazing losses at 450 MHz, when line of sight conditions do not prevail, are approximately 10 dB greater than at 150 MHz.

If the effective radiated power of a portable transceiver is 4 watts (36 dBm), for example, and the transmission losses are 114 dB, the level of the signal at the receiving antenna will be -78dBm (30 microvolts). If the gain of the receiving antenna is 10

Table 1—FCC Allocation of Frequencies for Remote Pickup Broadcasting in the United States.

(1)		Group A (Kc/8)			
		1 1606			
		1622			
		1646			
(2)	Group D (Mc/8)	Group E (Mc/8)	Group F (Mc/8)	Group G (Mc/8)	Group H (Mc/8)
	2 25.87	2 25.91	2 25.95	2 25.99	2 26.03
	26.15	26.17	26.19	26.21	26.23
	26.25	26.27	26.29	26.31	26.33
	26.35	26.37	26.39	26.41	26.43
(3)		Group I (Mc/8)	Group J (Mc/8)		
		2 26.07	2 26.09		
		26.11	26.13		
		26.45	26.47		
(4)		Group K (Mc/8)			
	3 152.87	3 153.17	5 161.64		
	3 152.93	3 153.23	5 161.67		
	3 152.99	3 153.29	5 161.70		
	3 153.05	3 153.35	5 161.73		
	3 153.11		5 161.76		
(5)		Group L (Mc/8)	Group M (Mc/8)		
		4 166.25	4 170.15		
(6)		Group N (Mc/8)			
	450.05	450.55	455.05	455.55	
	450.15	450.65	455.15	455.65	
	450.25	450.75	455.25	455.75	
	450.35	450.85	455.35	455.85	
	450.45	450.95	455.45	455.95	

Table 2—Frequencies In MHz

Channel	VHF BAND				
	Order Wire Transmitter	Order Wire Receiver	Order Wire Transmit	Portable Transceivers Program Transmit	Order Wire Receive
1	152.93	161.64	161.64	—	152.93
2	—	—	—	161.70	152.93
3	—	—	—	161.76	152.93
UHF BAND					
1	450.05	455.05	455.05	—	450.05
2	—	—	—	455.25	450.05
3	—	—	—	455.35	450.05



Fig. 1

Hand-carried transceivers for 132-174 MHz, made by Communications Company, are available in 2-watt and 5-watt ratings. Left unit runs on D cells; right on rechargeable nicad batteries.

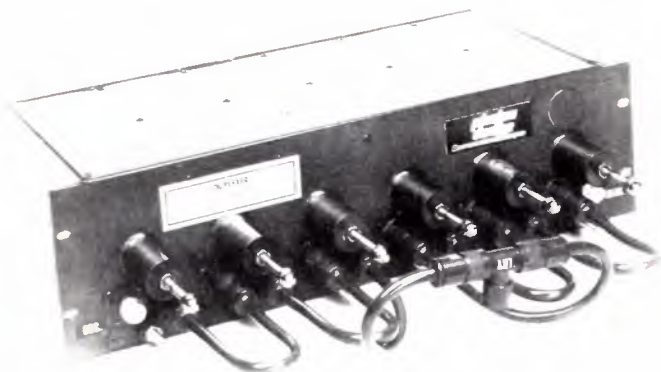

Fig. 4

Duplexer, made by Phelps Dodge, allows use of same antenna at receiving location for both transmission and reception.



Fig. 2

Motorola's hand held portable with external microphone can be carried in a belt holster.



Fig. 5

A 16 channel dual band scanner receiver will scan the band automatically or manually. This one is made by KHS, Inc. Such receivers can be equipped with crystals for weather channels and other services for direct rebroadcast (see story).



Fig. 3

Example of set up at station end for hand portable medium power transceivers. Duplexer feeds order wire transmitter (left) and, through a splitter, two receivers—one for communication over direct telco line, one for feeding remote pickup to studio.

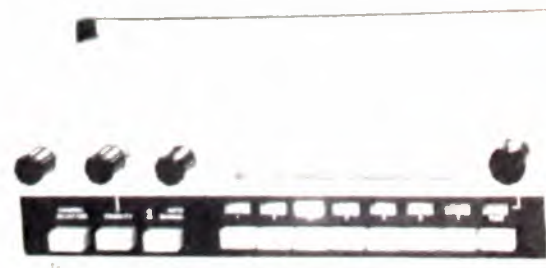

Fig. 6

A combination tunable, fixed-tuned, and scanning receiver available from Radio Shack, to which weather, police, and fire channels can be added, as to preceding unit.

dB and the transmission line loss is 2 dB, the net gain of the receiving antenna system will be 8 dB. This means that the signal at the receiver input will have a level of -70 dBm or 70 microvolts. An increase in transmission losses of 26 dB from 114 dB to 140 dB will reduce received signal voltage to 3.5

microvolts which is still highly satisfactory.

Examples of portable transceivers are shown in Figs. 1 and 2. An example of the equipment requirements at a receiving location is shown in Fig. 3. The high gain antenna is connected to an antenna duplexer, such as the one shown in Fig. 4, and its

WHEN On-The-Air Reporting

For on-the-scene, on-the-air reports, or for coordinating efforts of the news team, two-way radio has become an extension of the radio/TV newsman's stock in trade.

At WHEN, Syracuse, N. Y., portable equipment is used to cover morning and afternoon highway traffic conditions. General Electric's solid-state FM Porta-Mobil unit worked out to be ideal for getting reports from aircraft.

WHEN arranged with Sair Aviation, Inc., Hancock Field, Syracuse, to provide the aircraft and the pilot/reporter for the status reports. But Sair preferred not to guarantee that the same aircraft would always be used for the reports because of its charter commitments and maintenance schedules.

To offset the problem of using more than one plane, and problems of weights and balances, it was decided that the Porta-Mobil be used and switched between planes. From the height of the flying aircraft, the unit provides all the high-band coverage and more required for the service in the special broadcast frequency assignment.



WHEN Radio's Jack Morse uses General Electric Deskon to his right in the control room to contact the airplane. When the studio is ready to have the traffic report broadcast to listeners, he "brings it in" through the console in front of him.



With the Porta-Mobil at his side, F. Sam Hall, pilot/traffic reporter, is able to give WHEN listeners the latest facts on highway conditions below. A noise cancelling microphone cuts down extraneous noise.

The plane generally used is a single engine, low-wing Piper Cherokee. Pilot Sam Hall carries the Porta-Mobil onto the plane and puts it on the floor next to him. The unit is equipped with a special noise-cancelling microphone to reduce the plane noise. Hall takes his "cue" off-the-air with a small AM radio.

Back at the studio, the "on-the-air" personality of the drive-time show brings reports in through the broadcast console. If it is necessary to talk with Hall while not broadcasting traffic reports, to get special information or to make sure that all is in readiness, the announcer can carry on two-way communication with the pilot through a General Electric Deskon remote unit on a stand immediately to his right.

The traffic condition set-up also can be used for special news coverage as part of the regular news gathering two-way communications system used by the station. It includes GE mobile units in a radio news cruiser and TV news van, two Deskons, Porta-Mobil, and GE MASTR Professional base station. One Deskon is in the radio control room; the other is located in the radio newsroom.

outputs are connected to the order wire transmitter and through a splitter to two receivers. One of the receivers is used for order wire communication (direct telco lines) and the other for receiving over-the-air programs from remote pickup units.

Examples of frequency allocations are noted in Table 2. The channel numbers refer to the portable transceivers, not the base station. If the portable transceivers have only two-channel capability, the Channel 3 listings are not applicable. In any channel position, the portable transceivers are equipped to receive on the order wire frequency.

The actual frequencies to be requested by a station depend on which ones are vacant or lightly loaded in the area. (Applications are covered in FCC Rules Part 74, Auxiliary Services, Subpart D.)

The order wire receiver can be a single-channel fixed-tuned type. (In the VHF band, a marine type to monitor 156.8 MHz, the marine safety and calling channel, is suitable.) The program receiver can be a dual-channel fixed-tuned type or, preferably, a scanner monitor receiver.

A "scanner" monitor receiver, such as those shown in Figs. 5 and 6, is versatile and offers the broadcaster a number of capabilities. For example, a 150-174 MHz band, 8-channel scanner receiver can be equipped with crystals for two or three high-band remote pickup channels, and a National Weather Service channel (162.4 MHz or 162.55 MHz, depending upon the frequency of the regional weather news broadcast station), for picking up programs for immediate broadcast or taping. (It is permissible to rebroadcast National Weather Service broadcasts.) In addition, crystals can be installed for local police and fire channels to enable the news department to be alerted about local happenings around which news stories can be developed. In areas of marine activity, a crystal for receiving on 156.8 MHz can be installed for intercepting marine distress calls.

When the remote pickup units operate in the UHF band, a 450-470 MHz single-band scanner receiver can be used. More versatile is a dual-band 150-174 MHz/450-470 MHz scanner receiver which can be equipped with crystals for one or more UHF band remote pickup channels and for one or more police/fire channels in either band plus the weather channel.

A scanner receiver, when set in the automatic mode, samples each channel in sequence. When it finds a live channel, it locks up on that channel until the transmission ceases and then the scanning operation resumes. A switch is provided for cutting in or bypassing any of the channels. Continuous reception can be limited to any one channel by setting the switches for all other channels in the off position.

When used for picking up signals from two different sources, such as for rebroadcast or taping, the scanner receiver can be set to receive on two different remote pickup channels. When remote unit A, for example, is transmitting, the receiver locks up on its channel. When remote unit A ceases transmitting and remote unit B starts transmitting, the receiver switches automatically to its channel. Thus,

continued on page 56



Inexpensive scanner is the "Jolly Roger," made by Electra Company. It will be on the market in the spring. Intended for consumers, the unit tunes the broadcast band and also includes a two channel scanning monitor for police and other higher frequency services. It runs on D cells or ac. We can envision roving newsmen monitoring one's own station and police band at the same time.

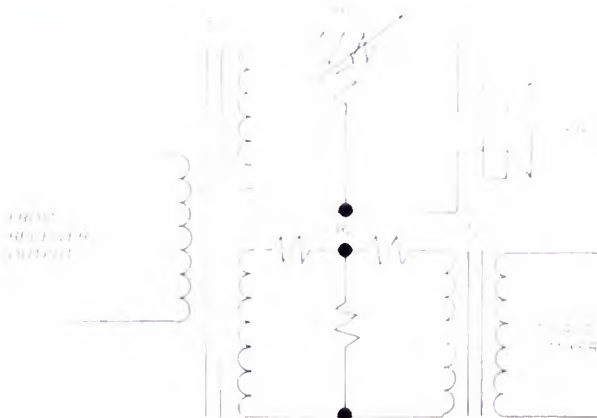

To monitor receiver output and feed the studio console at the same time, the circuit shown above is often used. T1 is a "Mix-N-Match" transformer.

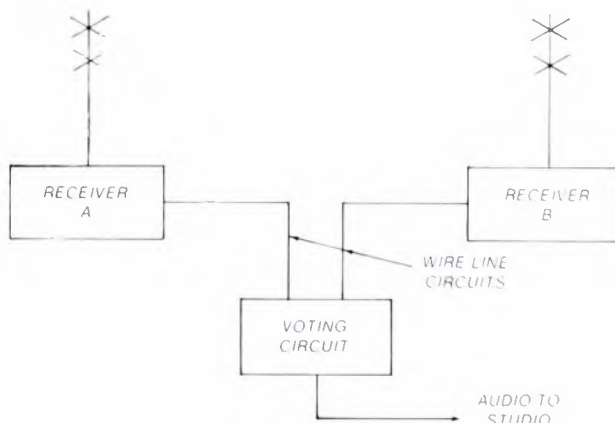

When two or more receivers at different locations are needed to assure pickup from the remotes, they should be fed to a "voting circuit" (commercially available) which continuously chooses the one with the best S/N ratio.

Is Videotape Taking Over? Can Film Hang In There?

There is no "winner" yet. Keep your film chain and your VTRs. Film is still it in news, but the complex mix of tape and film we've had in making entertainment programs and commercials for TV is shifting strongly toward tape. Here are the reasons.

MAGNETIC TAPE SET OUT in the fifties to conquer the production of packaged material for television, but managed to take over only some parts. Recording the news is not one of those parts. Headway in other areas has not been easy. In the origination of many kinds of entertainment programming and of most nationally-distributed commercials, and in the distribution of much of this material, film has long held a strong position. Thus, as every television operator knows, the two media have been uneasily sharing the scene, with some forward forays there, a few retreats elsewhere, and no winner-take-all showdowns.

But the balance between the two is highly sensitive to technical advances, and we are in a ferment of technical advances. In the last two years the advantages of videotape have begun to outweigh those of film in a number of important respects, and tape is moving into some film strongholds.

To get a measure of the extent of this shift and a clearer idea of its meaning for broadcasters, *BM/E* talked to a number of people in the advertising and syndicated program industries, where the choice between tape and film is made almost on a day-to-day basis from readings of the latest technical and

economic parameters. Their testimony confirmed the existence of a strong trend to tape. Film is still well in command in some areas, but tape is taking over chunks of film territory.

"It's not a revolution, it's a fast evolution," said Mort Dubin, vice president of Director's Circle and widely known as a member of the fraternity who independently create and direct nationally-distributed commercials for TV. The independent TV ad director chooses technical facilities for each job, renting whatever he needs from the plenitude of film and tape facilities available by the hour or the day in the larger cities. In this competitive atmosphere the relative merits of the two media get a practically continuous re-assessment. "I estimate that tape went up about 50% in 1972 as compared with 1971. Right now, I think about 20% of ad production and roughly 30% of ad distribution is on tape," said Dubin.

Everyone we talked with agreed with that general assessment, and many put the tape/film ratio much higher. What does the trend to tape mean to the television broadcaster? Here's the story in some detail, first as to the origination of programming, and then as to its distribution.

Origination

When video recording started to flourish in the broadcast industry in the fifties, there were waves of fright in Hollywood. Would the new medium, as some tape men were predicting, simply obsolete film and film personnel?

In a few years it was clear that no such revolution was in sight and Hollywood settled back into its traditional routines for making visual programs, including vast quantities of material for television.

But now, in the early seventies, the video camera is at last making a real thrust toward the central role in movie making. A number of major studios have made one or more recent releases apiece with video cameras, and all are said to be experimenting with it. The movement includes not only the Hollywood movie in the old sense, but also the whole range of syndicated visual programming and commercial production for television, for which film has long been the preferred technique. The motion picture industry is watching without panic, because it is now clear that "videography," as one old movie hand has dubbed movie-making with electronic equipment, needs most of the same old movie skills (as well as

some new ones).

The accumulation of new with old technical advantages for the video camera finally tipped the balance toward tape.

Here are the special capacities that the movie makers like in electronic production:

- Instant replay—it saves big hunks of time and money—if the first take is wrong, the director knows right away and can reshoot without leaving the set;
- Totally quiet cameras that accommodate a wider range of light values and color temperatures than film cameras;
- The current high-band VTRs—these lifted recording quality to the level the movie makers wanted;
- Ability of the current video cameras to use a range of lenses similar to that of film cameras;
- The TV monitor as a large, well-lighted, easily multiplied viewfinder, which sees exactly what the camera sees;
- Recent advances in editing technology which make editing videotape easier and cheaper than the old standard film editing methods;
- Recent developments in small van-mounted vi-

deo production units, with two or three cameras feeding control equipment and recorders in the van. Set up time is usually much faster with this equipment than with transportable movie units, (for example, the cameras can be warmed up on the way to the shooting site);

- Capping it all is electronic processing of the program: color, aperture, gamma correction; picture enhancement of various kinds; dissolves, wipes, all the bag of special effects that the TV broadcaster today expects to come out of a smallish box when he punches the buttons.

What about picture quality? The resolution of a frame of 35mm film is, of course, many times that of the standard TV raster. But the electronic system resolution is good enough, with careful correction all down the line, for acceptable projection prints on 35mm to be produced from it. And the quality of the electronic system is definitely better than that of 16mm production, everything else being equal. Further, as described in a moment, the technology of video-to-film transfers is in a phase of radical improvement—we can look for big forward steps in quality for this operation.

Color correction on film is a much more cumbersome process, and the film technique lacks totally the capacity for picture enhancement at the sophisticated electronic level.

On one count, that of extreme mobility, the film camera is still ahead and likely to stay there.

The television broadcaster knows the virtues of the video camera—it has been his bread-and-butter instrument from the beginning. He may not yet have

caught up with, or gotten around to buying, the latest in video processing equipment. In any case, the major point here is that video camera, video processing, and video recording technology have moved ahead far enough to make electronic origination attractive in anybody's league: the broadcaster with his video camera need have no sense of inferiority to film technology when he comes to making the most finished dramatic productions. He doesn't need to go outside his electronic territory. The movie industry is starting to move in with him.

The old attitude barrier to the use of electronic origination included a pattern like this: the video camera is fine for giving a sense of immediacy, for "actuality," for a newsy, documentary effect; but for real drama with every part of the frame counting, film has to be it. It is now clear that this attitude is an anachronism. Testimony on the point came from Bill Moseley and Joe Sacco, of the New York advertising firm of Moseley and Sacco, and creators, in various ad firms, of TV ads for Borden, Hertz, Jeep, Chanel, PepsiCo, Continental Can, and many others.

"I used to have a good feel that an ad was a tape ad or a film ad," said Bill Moseley, who has faced the question scores of times, "but today we are getting material from videotape that I can't tell from film material, and I know the game has changed. The video camera has grown up."

Being grown up means not only that the video camera is on an optical and quality par with the film camera, but that the personnel of electronic origination now have the tradition and the accumulation of skills to do the job. Very important in this area is the



Joe Sacco (left) and Bill Moseley try out an advertising idea (see story) by interviewing shoppers in a large store. Comments will help guide ad production, which is increasing on videotape these days despite the extreme flexibility of film equipment as shown below.



Handbooks For Purchasers of Film Processing

Television broadcasters producing program material on film—news, commercials, or whatever—will in most cases deal with commercial motion picture film processors. The Association of Cinema Laboratories, a trade group which includes leading processors in cities across the country, has issued a "Handbook of Recommended Standards and Procedures for Motion Picture Laboratory Services," a most comprehensive manual on how to prepare film for processing or printing. The book is clearly and simply written, and covers just about everything a film producer might want done on 8mm, 16mm or 35mm film, from how to pack unprocessed film for shipment to preparation for every kind of splice, fade, dissolve, etc. The handbook is available, from your local film laboratory or from ACL, 901 N. Washington St., Alexandria, Va. 22314, at \$3.00 per copy.

Also of value to the film user is a pamphlet reproducing 14 articles on film techniques by Byron Roudabush of Byron Color Correct, tape and film laboratories at 65 K Street, N.E., Washington, D. C. 20002, from whom copies may be requested.

perfection of the multi-camera technique for movie making with (usually) three cameras simultaneously recording the scene from different viewpoints. This long-familiar technique of TV broadcasting has special virtues for movie making or any drama program. The director gets obvious editing scope and can give his program contrast, timing and variety with much the same results as the film director. The new technology has made the editing, as already noted, easier,

quicker, more readily responsive to aesthetic decisions, on tape than on film. The CMX automated editing system, in particular, (see *BM/E*, July 1972, page 16) is stirring wide enthusiasm in the movie and commercial-production industries. But less elaborate, less expensive editing techniques put videotape far enough ahead on this score to make it today a highly responsive instrument for the producer.

Costs — Overall, Tape is Winning

That same quickness and ease of editing give tape one of its big plusses on the cost side.

The BBC television department, for example, which recently published a study of the comparative merits of film and tape in producing television drama programs, found they were getting about four minutes of film program in a day's work (shooting, editing, etc.), but 30 minutes of tape program. Personnel requirements were roughly the same.

Further, the "shooting ratio" on film was around 8-to-1—8 feet shot for every foot in the final program. On tape, it was 1½-2-to-1. Thus, the total cost of material for a 30-minute program on film was over \$1600; for a similar program on tape, \$75, taking into account the reusability of the tape.

Other programs made by other producers would, of course, show a great range of costs with the ratio between film and tape varying widely but, in production cost, tape has the inherent advantage and would generally come in at far less than film.

The original capital investment for tape production is far more expensive than a comparable capacity for producing on 16mm film. But with the running costs so much lower on tape, the cost over some reasonable period of time becomes comparable to that of film and eventually lower. The people we talked to agreed generally that the higher original cost of tape equipment is not hindering its acceptance among organizations that produce any regular, substantial quantity of video programming for television.

Duplication and Distribution

The distribution of syndicated programming and non-local advertisements is a huge area of competition between tape and film, quite separate from program production. Television broadcasters, as the addressees on the packages, are generally aware that the former heavy domination of this area by film is diminishing substantially in favor of tape.

Film had held sway here for a long time mainly because: the per-print cost of duplication on 16mm film was considerably lower than that of tape; in earlier days, many small television stations did not have the top-quality VTR equipment (or not enough of it) for convenient use of tape, while everybody had a 16mm film chain; many-print tape duplication had not been raised to a high level of efficiency; and again, there was an attitude barrier—everybody knew that the way to get a lot of copies of a visual program was to send it through those high-speed film printers.

None of those factors has a controlling power today. The per-print cost of 16mm copies is still a lot lower than the per-copy cost of tape, but the overall cost of tape duplication and distribution is now at least comparable to, and in many cases lower than, that of film. One main reason is that tape copies last a great deal longer than film copies (more on that in a moment). Tape duplication is more flexible: making just five more copies, for example, is easy on tape, more costly on film. Tape duplication has reached high efficiency.

Even more important, top quality tape playback equipment is now so general in the television indus-

try that a tape program can get practically 100% usage. Many stations will dub the material onto carts; in any case they will be able to get it on the air in good shape.

On the maintenance of quality in the copies, a factor of extreme importance to the advertiser, Jim Hartzler of Reeves Cinetel—perhaps the largest complex of rentable film and tape production facilities in the New York area—said: "Film copies simply do not hold up as well as tape. After five to ten playings a lot of the film copies you send out will have material edited out (that means material permanently lost), sprocket holes torn, scratches, plenty of dirt, and accumulation of non-compatible cueing cuts or marks. The broadcaster's editing and cueing of taped material does not have to make permanent changes in the copy. We are swinging heavily to tape distribution."

The advertiser himself has strong motivations for using tape. Dick Dubé, production manager of radio and TV advertising at Lever Brothers, one of the biggest TV advertisers, said this: "The three main reasons why we have gone 100% to tape for distributing TV ads can be put in one word each: better, cheaper, faster. The cheaper arises mainly from the far greater longevity of tape copies: we've had copies on the rounds for a year that come back still in usable shape. I think there is a psychological factor: to many users a piece of film seems an inexpensive thing and doesn't get the care they give to magnetic tape."

John P. Ballinger of Vidistrib, in a paper before

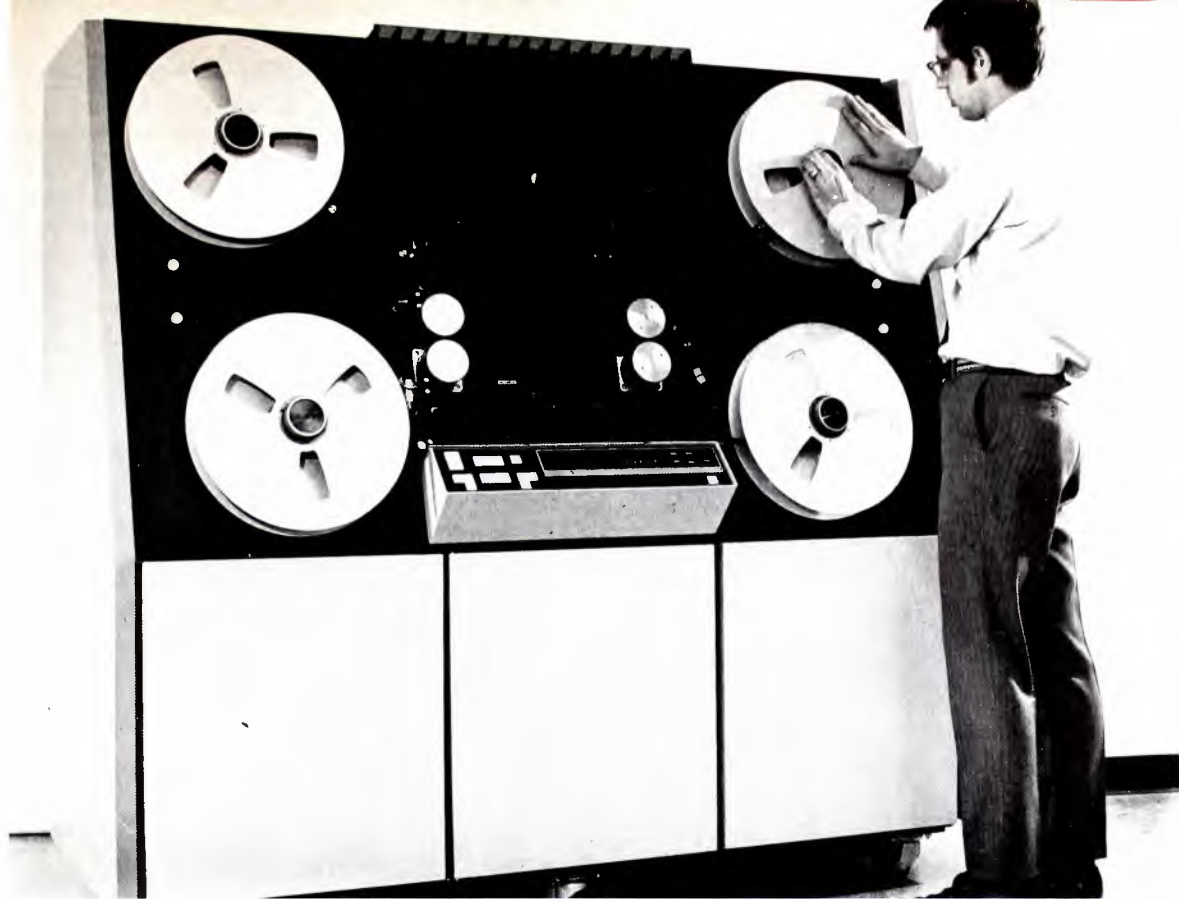

Distribution of programs and national advertisements on videotape is growing rapidly in part because of new efficiency and lower cost of videotape duplication. Prime example of state-of-the-art duplication is the Ampex ADR-150 contact duplicator (above) which makes copies at ten times playing speed.

the SMPTE Convention in Los Angeles last October, seconded the observation that film copies get much worse treatment in many television stations than tape copies. The main reason, as he sees it, is that film copies are often entrusted to untrained personnel (anybody can run a 16mm projector), while trained operators must run high-priced videotape machines.

As the foregoing has set forth, the shift to tape is not total yet by any means. Richard Kloss of Screen Gems, one of the largest syndicated-program producers, sees it now as around 50% each way, with

tape coming ahead. Thus, though tape may be the preferred medium of the future, there is right now a vast quantity of film material going out. The television broadcaster can't retire his film chain yet—or perhaps ever.

If for nothing else, he will need the film chain for the large quantity of non-theatrical, non-advertising material that now circulates to broadcasters on 16mm film and by all signs will continue to come along: public-service material, local interest material, etc., etc.

New Tape-To-Film Technology

The technology story on both film and tape, and especially on their interfaces and interactions, is an exciting book-full at this moment in history. Whatever happens in the competition between the two media the quality of tape, film, and tape-film combinations is shooting up. The following is a very brief summary of some highlights.

For *tape-to-film transfers*, which in old-style equipment suffered from the degradation inherent in photographing the screen of a TV picture tube, some radical new systems are in development that jump over the "phosphorizing" of the program, and make full use of the state of the art in video processing.

The 3M electron-beam video-to-tape machine, one of the first of which is now in use at Reeves Cinetel, converts the video information from tape or directly from video cameras into the varying intensity of an

electron beam that scans the film in a vacuum chamber. Each color frame becomes three frames on the film "negative," one frame for each color. The negative then goes into a "printer," where three frames are combined into one on the color print.

The immense advantages of this system lie in the far higher resolution of an electron beam than of a phosphor-produced light image; the very high photographic energy of the electron beam, which makes extremely fine grain film usable for the negative; and also the ability to use the most elaborate and sophisticated video processing, *ahead* of the filming, for color correction, image enhancement, etc.

Sig Utlek of Reeves showed *BM/E* an example of the 16mm color prints that come out of this process. The color was extremely pleasing, conveying a strong sense of "truth," and the clarity and resolution of the

pictures were exceptional. Even better results are expected in the future when Eastman Kodak's new color negative film gets into use in 1973.

The Eastman color negative film 5247 7247 provides a dramatic improvement in sharpness and



Typical of state-of-the-art telecine equipment, which improves airing of film material by automatic color correction, is new RCA TK-28 system.

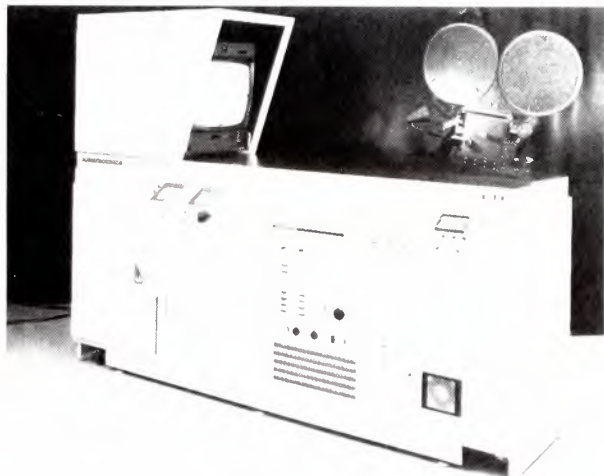

Teledyne system (see story) is popular for making high-grade video-to-film transfers.



Use of videotape in original shooting of motion pictures and advertisements is being greatly encouraged by a flock of new, highly efficient videotape editing systems. With one of the most highly automated, the CMX system, the editor merely applies a light pencil to screen (above) to "tell" the system what he wants— follow-through is automatic.

grain. ABC network engineers, after viewing a demonstration last fall, feel it will provide 35mm quality in the 16mm size.

Processing for the new films has been reduced to less than 12 minutes exclusive of drying time, less than one-third the time required for the old Eastman color negative film, representing the first change for Eastman color negative film processing in 20 years. The new process provides better recovery of chemical effluents, and potentially toxic materials in processing have been eliminated. Because of the new process, however, laboratories will have to install new equipment.

The new product will replace Eastman color negative film 5254/7254 and is scheduled to be available in mid-1973. The development of this new film demonstrates well the point that film advances will be made. Over the years both speed and quality have improved.

Another radical development in this area has a similar basic rationale, but uses *laser beams* instead of electron beams: it is the CBS Laser Beam Recorder, described for *BM/E* by Robert Walker of CBS Laboratories, one of the developers. Here the video information is converted into the intensity of three laser beams, one of each primary color. With half-reflecting mirrors, the beams are brought onto the same optical axis and applied through an optical system to the film.

Again, extremely high resolution is available, and high photographic intensity, as well as the most sophisticated color and image correction and enhancement ahead of the filming. A major difference is that a vacuum is not required. In fact, with the CBS system the film camera can be moved away and the optical system adjusted to use the machine as a video projector.

Since the internal scanning standards of the machine are not necessarily tied to television standards (the same is true of the 3M system), the projected image can have a higher line rate for greater resolution. The resolution is already high enough for very superior 16mm film making and Mr. Walker told *BM/E* that CBS is working toward resolution that will allow the machine to make theatre-quality prints on 35mm film.

Another operation involving highly advanced techniques in transferring videotape information to film is being used by a firm on the West Coast, Image Transforms, which is making superior Super 8, 16mm and 35mm copies of VTR material. Details of the film exposure process had not been revealed as this was written, but the firm does say that patented signal processing methods, ahead of exposure of the film, are a vital part of their results. For example, the system is said to remove about 80% of the "subjective" noise from tape, allowing for pre-emphasis that sharpens the images. The television signals from the Apollo 16 moon mission were fed from Houston to Image Transforms for processing and fed back to Houston in a small fraction of a second, for viewing there and distribution to the TV networks.

We see here highly promising developments from the point of view of the movie maker considering video production vs film production. He can make

and store his movie in electronic form: as the new transfer methods become fully established and perfected, he will be able to put the program into film form for distribution with no loss of quality—in fact, with potential *gains* in quality from the electronic processing.

As for distribution to television stations, the CBS

laser machine at their headquarters, the only one in active operation so far, is being used mainly to put on film network shows, promotion pieces, and other material being sent to CBS affiliates around the country. The quality of the 16mm material the machine produces, like that from the 3M electron-beam machine, has been very impressive to industry observ-

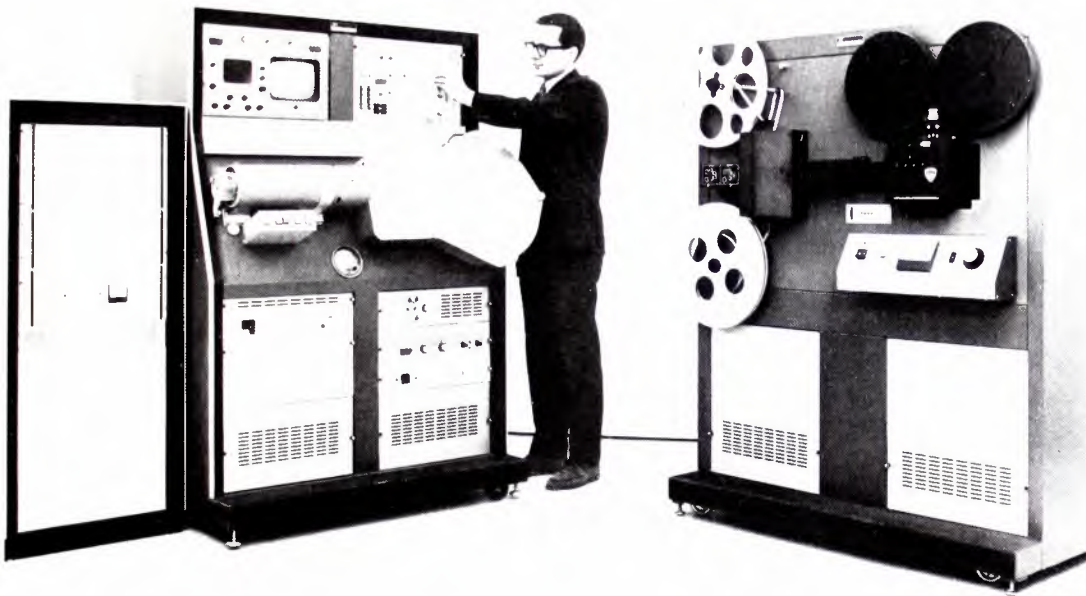

3M's electron-beam video-to-film transfer system includes the film exposure or recorder unit (far left) and the printer (near left). Electron beams strike moving negative film in a vacuum chamber, scanning three frames for each one in original video program, one for each color, on the color negative. The printer combines three frames into one on print. Recorder includes elaborate video processing for color correction, picture enhancement.

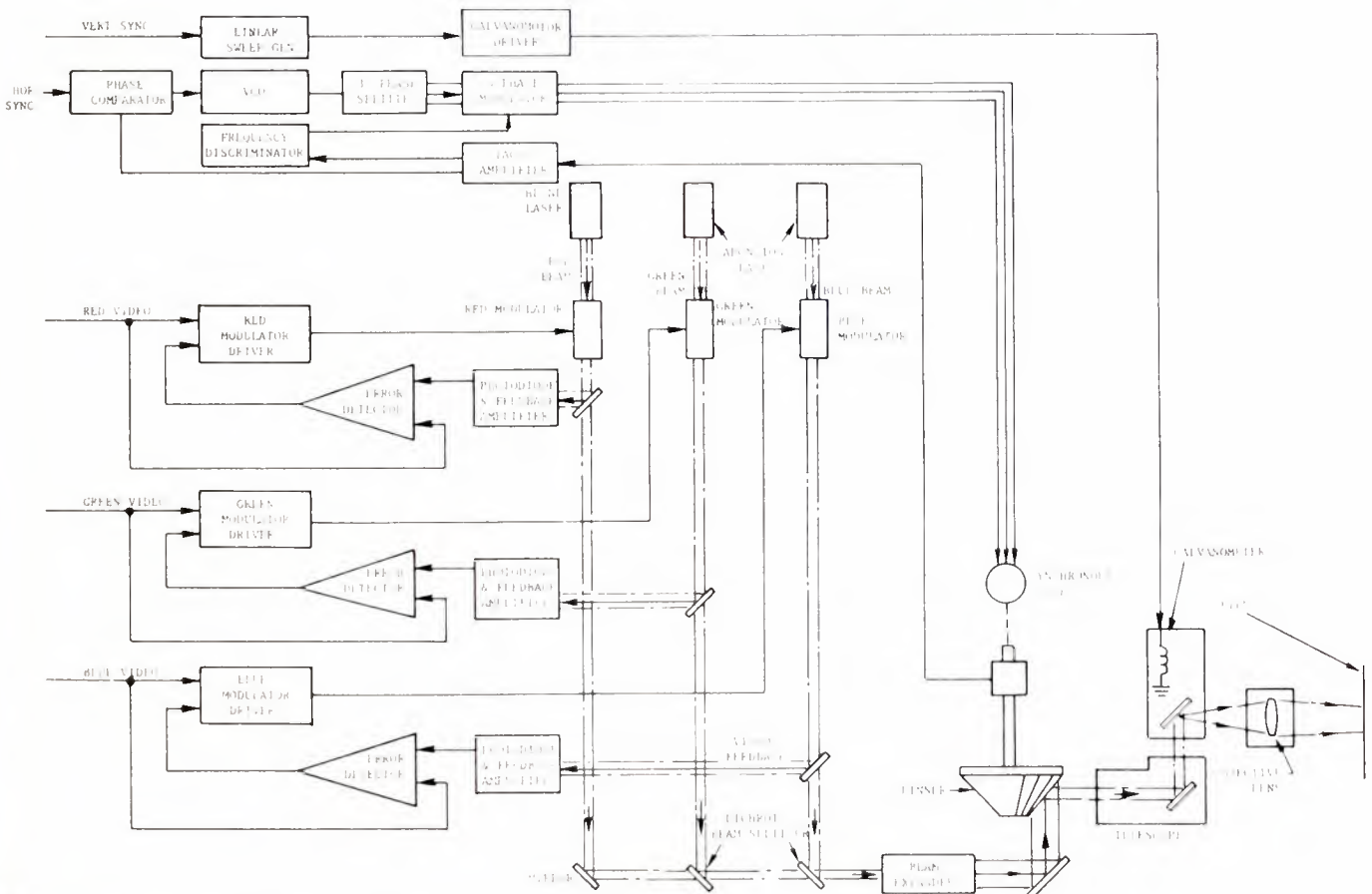

The CBS Laser Beam Color Recorder, shown in simplified block diagram above, uses a separate laser for each primary color, with the three beams combined into one by dichroic beam splitters. Horizontal scan comes from spinning many-faced mirror; vertical from galvanometer mirror. System also allows operator to use extensive video processing ahead of film exposure.

ers. Whether or not this high film quality in itself will stay or reverse the trend to tape in the distribution field was certainly not clear as this was written. In any case the new super-advanced video-to-film systems have great significance for the motion picture industry, as we have noted.

There are a number of areas on the edge of broadcasting, or fully outside it, that will remain as very large-scale users of 16mm film material: screening rooms at ad agencies, the vast school area, industrial training and promotion, and others, with literally thousands of 16mm projectors. The new tape-to-film processes will have great relevance for these markets. Reeves, for example, is already servicing the outside-broadcasting areas with film produced by its elec-

tron-beam recorder. Further, in many foreign countries the television industries are still mostly on 16mm film for packaged material, so that American producers, whether of entertainment or advertising material, will need film for effective foreign distribution of their product.

The radically new developments in this area were not fully in commercial use when this article went to press, although all were turning out some commercial material. One of the most used systems, the Teledyne video-to-film equipment, has for some time had a major role at outfits like Screen Gems and the American Broadcasting Company. Here again immense advantage is gained from electronic processing of the signal ahead of film exposure.

Film Still Dominates In News

Despite the inroads videotape is making in areas of commercials and dramatic productions, film is king in news. The most popular TV camera-type setup is the Philips PCP-90 in conjunction with the Ampex VR 3000. (See separate box on how WCVB uses this

combo.) This gear has made it possible for some stations to get a news beat on their competition. Notable example—WTOP beating others on the air with Henry Kissinger's surprising revelations on progress of peace talks last October. While other sta-

Videotape For Community Affairs Program

A unique mini-van for on-location videotape recording won high marks on election coverage for Boston station WCVB-TV, channel 5, the area's newest station.

Officials of the station feel that the lessons learned under the pressure of election coverage will help their young station do an increasingly good job of talking with the community throughout the years.

WCVB used a converted Winnebago camper as a portable control room on Election Day. The entire unit—camera, recorder and two-man crew—sped from one political camp to another making tapes for playback at its Needham plant.

The camper is equipped with the Ampex VR-3000 portable high band color videotape recorder, easily carried by one crewman or used in the camper as a small studio recorder. The camera used is the versatile PCP-90 portable video camera from Norelco.

Portability and mobility are exactly what station planners had in mind when they purchased the equipment and camper completely stripped except for a powerful 7½ kw generator.

The mobile videotape unit demonstrated it can reach most locations and prepare broadcast-quality videotapes at the scene, thereby eliminating processing delays associated with filmmaking or complexities that go along with microwave transmissions.

By combining national coverage provided by the network with its own efforts, WCVB, an ABC Television affiliate, feels it may have provided the state's most comprehensive local and national returns programming for election night viewers.

From election morning to election night WCVB's two-man crew visited heavy voting areas in the Boston community. The results were "live" interviews with voters, comments and analysis by in-

cumbents and campaigners, district-by-district return estimates from local boards, and on-the-spot election concession speeches.

The VR-3000 and PCP-90 were carried into polling places and campaign headquarters and taped interviews were returned by courier to the WCVB plant on Route 128 South, 20 miles southwest of downtown Boston.

Once at the plant, the tapes were aired via the station's third generation Ampex AVR-1 highband color videotape recorders in prime time news programs or as inserts to local election commentaries.

WCVB purchased a full-sized video van from WHDH which is used as a second studio while one at its plant is under construction. When the studio is finished, the van will be used to originate on-location broadcasting of area bowling matches, for example—a different kind of need involving mobile video recording.

This larger van contains two Ampex VR-2000s and uses Norelco PCP-100s when interfaced with the studios.

The Winnebago camper, camera, recorder, and crew go where the big van is not used, and where smaller, more portable equipment can record and move about with relative ease.

WCVB uses one man to support the camera and batteries while the second man supports the 60-lb. back-pack color recorder. The PCP-90 used with the VR-3000 can also be used by the station as a live studio camera.

WCVB's community-mindedness — it originates 45 hours of live programming each week—means its teams of news and feature reporters have to get out to community meetings, concerts and ground breakings. With same-day air time required for fast-breaking events, these crews can view recordings made on camper monitors, edit tight segments, and send complete stories for the air within their own time allotments. Film still plays a big role in news coverage, but tape is preferred for community affairs.



Portable TV camera and tape equipment are valuable for nearly instant sports broadcasts.

tions' films were in the process tanks, CBS's videotape footage was on the air.

But few really expect electronic cameras to become a big factor—unless some new equipment hits the market. For one thing, it's still easier to pack around 16mm film cameras. Less paraphernalia. And of course film equipment is much less expensive, which bears on accessibility. A station might have 10 to 20 film cameras about for every good portable TV camera and portable VTR. In fact, some stations don't have any "portable" equipment—mobile perhaps, as in a van, but not really man-portable.

Cost figures in on the type of event to be covered by electronic means. One doesn't send a \$90,000 camera to the scene of a riot.

But the major deterrent to the use of video gear for news coverage is convenience. The PCP 90 has to work with a standard PC camera control unit—the cord connecting the two is lightweight, but nevertheless a constraint. A microwave link can be used, but then another pack is called for. In any event the camera control unit has to be in the vicinity. The VR 3000 is self-contained but has to be pampered—at least in comparison with film equipment. You just can't grab one from the closet and run. Stations which *BM/E* talked to said reliability is a concern and it takes a technician to make sure everything is in working order. Certainly one should have spare modules on hand, if not a second machine.

Even if a station shoots on videotape, it doesn't mean one can get on the air directly. There is the matter of editing. If a station is set up to work primarily with film, editing is a separate function with a room and equipment all its own. Videotape

coming in has to be handled on equipment being used for handling on-the-air programs. What we are saying is that there is no total electronic system geared expressly for producing news as there is in film.

Stations that might like to switch are not sure today's equipment is anywhere near optimum. The TV camera should be self-contained; the VTR should be lighter, more fail-proof. With the advances made in helical VTRs in recent years, there is hope that a unit for news gathering might appear—one that would be so ideal it would offset the disadvantage of having to be converted to quad standards before playback.

In summary

One thing is certain and can stand restating: the quality of packaged video programs, tape *and* film, is going up, up. The television broadcaster who wants to take full advantage of that improvement may want to look at his equipment, to make sure he is ready for what is coming.

Whether the broadcaster will be concerned mostly with tape or film is not nearly as certain. The odds right now are for more and more work with tape, both in the broadcast stations and among suppliers of packaged programming. But film will be here a long time unless there is some new, even bigger breakthrough in tape technology. That is pure "if," so keep your 16mm projector oiled and cleaned—or buy yourself a new one, fully up to the better film you will be seeing. We can assume that one or more top-grade VTRs are already key instruments of your operation.

BM/E

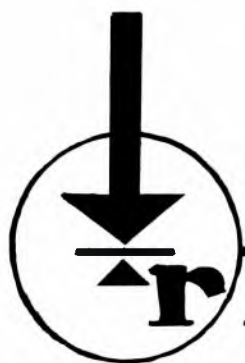

RICHMOND HILL LABORATORIES *TAKES THE LEAD*

IN TELEVISION AUTOMATION

Richmond Hill Laboratories takes the lead in automation with a sophisticated automated system. Contracted by a major Canadian T.V. Network to handle both local broadcast and central distribution. RHL's design, systems and manufacturing team will employ the latest computer technology to handle full automation of all network line delegation, VTR control and VTR assignment. This up to date system also engineered to allocate video and audio sources for the domestic satellite ANIK.

The most interesting aspect of this system is the videotape delay required to adapt to the coast-to-coast time-zone requirements. Delegation of machine control, VTR inputs and outputs as well as intercom is accomplished by three audio-follow-video routing switchers and a machine control assignment switcher. The system is completely automated but does have a manual master control override.

Video display via character generators supplies the presentation of each VTR machine schedule. The system permits display of total combined assignments scheduled and uses digital cassette tapes to feed all scheduling data to computer. The computer logs all activities onto cassettes for later transfer to printout form.

Follow the Leader... Follow RHL

RICHMOND HILL LABORATORIES INC

142 CENTRAL AVE., CLARK, NEW JERSEY 07066

CANADA

1240 Ellesmere Rd.
Scarborough, Ont.
M1P 2X4
(416) 291-7921
Telex 02-29803

MIDWEST U.S.

370 Nottingham Lane,
Hoffman Estates, Ill. 60172
(312) 882-4622

EASTERN U.S.

142 Central Ave.
Clark, N.J. 07066
(201) 381-5955
Telex: 138245

ENGLAND

Pinewood Studios,
Pinewood Rd.,
Iver, Bucks.
SLO ONH
Telex: 847505

An Encoder That Updates Your Camera

Camera features such as luminance black stretch and noise stripping are available in the latest camera designs. You can get the same thing out of your old camera with the TCE-300 encoder developed by TeleMation. How all this came about comes out in the transcript of an interview with Lyle Keys, president of TeleMation, by Jim Lippke, editor, BM/E.

Is this new encoder a fall-out from your Chroma III camera efforts?

It is an outgrowth. When we initially set forth the design objectives of the 3100 camera, we saw a need and a marketing opportunity for a camera that could operate at full broadcast standards with all of the necessary circuitry in the camera head itself to produce an NTSC picture. That necessitated having an encoder mounted in the camera head. The constraints that placed on the encoder design were considerable because heretofore encoders have always been mounted in racks in the control room of the station, or in the remote truck. In any event, they were accessible for adjustment. They had instrumentation such as Vectorscopes available nearby facilitating those adjustments, and they were operated under protective environmental conditions.

Once you put the encoder inside the camera head, it has to operate without drift or failure when you take the camera up on the ski slope or out on the desert. And even in a studio configuration, the camera head is not accessible for adjustments, since the instrumentation (the Vectorscope) is necessarily in a rack in the control room and the camera is confined to the studio. So there is little opportunity to make the usual adjustments that are used on encoders, using a Vectorscope as the test instrumentation.

Our approach was to use as much digital circuitry as possible to increase stability and to minimize adjustments. This encoder was developed for the camera. We then looked at the encoder as a free-standing product so that users of present television cameras could upgrade their service. Having no mechanical parts, an encoder could be put into production much faster than an entire camera.

How do you get color vectors from digital circuitry?

The encoder incorporates a novel method of developing the phase relationships necessary to produce the NTSC signal. We take the 3.58 MHz subcarrier input and use it to trigger an oscillator that operates at four times that frequency. This results in a digital

waveform that has transitions at each 45° increment of the 3.58 MHz subcarrier frequency. By a precision matrixing method, we are then able to derive any precise vector to an accuracy of better than 1/2-degree without use of any adjustments.

We make the claim that if the color bar output from this encoder does not produce each of the vectors, i.e., the dots that are displayed from these vectors, within the small box of the Vectorscope—which I believe represents $\pm 2^\circ$ overall limits—it is because the Vectorscope is defective. We can show that the inherent accuracy of the encoder is indeed considerably better than the Vectorscope (the instrumentation) that is used to measure it.

This matrixing, is it difficult to achieve at this frequency?

It's not difficult—it's new. The availability of integrated circuits that can switch at high speeds has given us the capability of doing things that we couldn't have done a couple of years ago. We know of no other development like this where phase shifting has been accomplished digitally.

Aside from the stability, what else?

We've added a couple of other features we feel are quite important. We have been very much impressed with RCA's demonstrations of their TK-44B camera. They have one feature . . . contrast compression . . . which stretches the black portion of the luminance component without affecting colorimetry. This allows you to provide better detail in the shadowed parts of the picture. Doing this causes an increase in noise. RCA compensates for this by having level-dependent aperture correction and by having a feature which they call "video coring." They "core" out a section of the video so that the small transitions created by noise are ignored, while the larger video transitions are allowed to go through at full bandwidth. Our encoder has these two features. We call them "Luminance Black Stretch," and "Noise Stripping." The "black stretch" allows us to provide about 6 dB

improvement in the luminance channel in the black portion of the waveform without affecting video level and without affecting the chrominance information.

Is that an expensive part of the thing itself?

Not particularly.

If someone buys this encoder, can he get the same benefits that RCA is showing?

Yes. And this is our objective in providing these features. While getting the features from RCA necessitates the purchase of a very expensive (although remarkably good) color camera, we feel that the existence of many hundreds of older color cameras of various manufacture opens up a good replacement market. We can offer a new encoder to improve stability and to provide these important new features. In many instances, we allow broadcasters to salvage their present equipment, whereas they might be under competitive pressure to buy more modern cameras otherwise.

That feature, black stretching, does it improve detail under lower light levels?

It doesn't improve detail—it improves contrast ratio in the darker, poorly lighted portions of the scene. In RCA's ad they show a camera looking down, say inside Yankee Stadium, showing the action moving from a sun-lighted area into the shadows. As the action moves there, because the camera has necessarily been set up to accommodate the higher lighting levels, and since a portion of the picture is still obtained from the well-lighted area of the stadium, it's not possible to increase the video gain. But the action's over in the dark area, so by changing the contrast ratio of the picture relative to the well-

lighted area, it's possible to reduce the emphasis in the well-lighted portion while increasing it in the darker portion. This is what is accomplished. And there is no loss of bandwidth or detail. It merely increases the video gain—the contrast, so to speak—in the black while maintaining overall video levels constant.

Could somebody else make a retrofit for their camera, say Norelco for the PC-70? I suppose they could.

They could, yes. But I don't think anyone else has chosen to do it. And I'm quite sure that this is the only free-standing encoder in the world that has these particular features in it.

What does the encoder do for telecines?

We've put a couple of other features in the encoder that are important for film applications. A lot of the old film has very poor color information. So we have, in the remote control panel that is available with this encoder, a "chroma boost" circuit that allows us to introduce 2, 4, or 6 dB of chroma boost in order to provide more color from films that are deficient, or scenes that are deficient in color.

Another feature for film is "Green Tie" which is also remotable. We enable an operator, when running a monochrome film, to take all the information from the green channel only in order to reduce registration errors. Also in the area of registration, if the camera involved has nominal misregistration, it may be desirable to take the higher frequencies of the luminance channel only from one channel, whereas the low frequencies are derived from matrixing all three of the colors. In the case of a badly misregistered camera, it may be desirable to take all of the luminance from the green channel. So we have two switches—one of which is luminance highs from green, and the other one is full luminance from green—so there are three modes of operation.

When running a washed out kind of film, can we say this chroma boost will give it more saturation in the color itself?

Yes. The TCE-3000 also has the expected features of an encoder. We have a level dependent horizontal aperture control, delay line type, with both the amount of aperture being adjustable to 12 dB, and the threshold, the point at which the output becomes effected, being adjustable.

What does level dependent aperture correction do for you?

Well, in cameras, particularly the new Plumbicon cameras, it is desirable to increase the detail in the brighter part of the picture without increasing the noise in the darker portions.

What are the options that you advertise?

Something that's new to the encoder field is our "VITS/VIRS" option. This provides a standard color bar output on any of four lines of the vertical interval in either or both of the fields. It is strappable

continued on page 55



TCE-3000 color encoder, now in production, is viewed with sales anticipation by TeleMation marketers, Frank Benson (left) and Russ Ide.

BROADCAST EQUIPMENT

Lightweight cordless 16mm sound camera has magnesium body, single/double sound system. Model MC-571 "Frezzi-Cordless" weighs 14 pounds complete, ready to shoot, with dc motor, 16 pounds with ac motor. Included are Angenieux AVS 12-120mm zoom lens, 1-in. finder with TV reticule, 400-ft magazine, battery, built-in crystal-controlled module for "dead sync" accuracy in 1200 ft of film. Running time: 8 to 10 400-ft magazines per charge on quick-change plug-in battery. FREZZOLINI ELECTRONICS INC. **275**

TV data display systems have two channels—one for data from any major news source (cable TV, other news wires), stock exchange, NOAA weather; the other channel for keyboard-generated local material. Centron Series have 512-character memory on each channel, automatic roll, split-screen model with two channels simultaneously displayed, single-character editing, color background, output for VTR as well as video line. VIDEO DATA SYSTEMS, INC. **276**

Cartridge video system for government training, education, maintenance, and testing, has portable tape player/recorder, and separate 17-in. monitor. Avco CTV system has random access indexing, skip and repeat, and programming with a remote control device. AVCO ELECTRONICS DIVISION. **277**

Electric wall clock has 24-hour dial with hours on circle separate from minutes circle for easy reading. The "Johnsville" clock runs from 110 VAC 60 Hz supply, has a sweep second hand, comes with either an 8 in. or 12 in. dial. \$18 and \$22, respectively. FRANKLIN INSTRUMENT COMPANY. **278**

Portable microwave transceiver simplifies microwave antenna alignment, provides both a microwave signal and two-way voice communication. Series 4600 Link Alignment System operates at 6 GHz, includes a remote meter, carrying case, battery pack, headset, and horn antenna for course alignment. \$3200. SCIENTIFIC-ATLANTA, INC. **279**

Cable trunk amplifier is for single- or dual-cable operation, with bi-directional capability on one cable. Super-Band Challenger Mark V uses push-pull, hybrid integrated circuitry, covers 30 to 300 MHz in forward direction and 5 to 32 MHz in reverse. It has dual pilot control. Intermediate and

terminating bridgers and line extenders are available. AEL COMMUNICATIONS CORP. **280**

High-power, three-port ferrite circulators for VHF and UHF frequencies, cover 150 MHz to 860 MHz. Series comes in 100 w, 300 w, 500 w, 1 kw and 2 kw power-handling ratings, all with insertion loss typically from 0.15 to 0.35 dB, and port-to-port isolation better than 20 dB. For interstage isolation and coupling in VHF and UHF transmitters, and for duplexing from a common antenna. AMPEREX ELECTRONIC CORPORATION. **281**

New generation of recorded open-reel tapes embodies a number of changes aimed at significant improvement in sound quality. Ampex II tape series will be Dolbyized in selected cases; will be made on low-noise, high output tape; have been duplicated on equipment with new electronics with 2.6 dB more dynamic range than earlier equipment; and with a number of other improvements in duplicating, mastering, and quality audit techniques. AMPEX STEREO TAPES. **282**

Four-hundred-foot magazine for ACL cameras is interchangeable with present 200-foot magazine. It clips directly onto camera body, accepts both daylight loading spools and core-wound film, causes no additional drain on camera battery or motor. ECLAIR CORPORATION OF AMERICA. **283**

Low-power AM transmitter is intended for carrier-current transmission, test site conductivity measurements, other low-power broadcast services. Model



720B is rated at 50 watts output, can be tuned to any frequency 540 to 1700 KHz, has frequency stability of ± 5 Hz, distortion less than 3%, noise -50 dB, efficiency 65%. SPARTA ELECTRONICS CORPORATION. **284**

continued on page 38

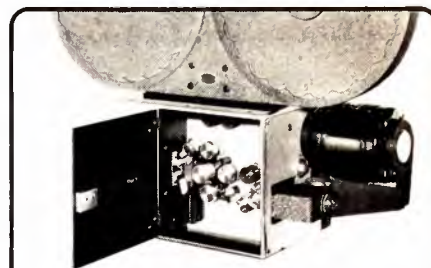

P EXPERIENCE COUNTS

■ PALMER VIDEO/FILM RECORDERS have been successfully transferring electronic pictures and sound to motion picture film since 1962.

Unique camera design guarantees steady, sharp recordings every time in color or black and white. Video synchronizing problems are eliminated. The Palmer camera records from either broadcast or helical scan videotape without special adjustments.

Well built, dependable, and surprisingly low cost.

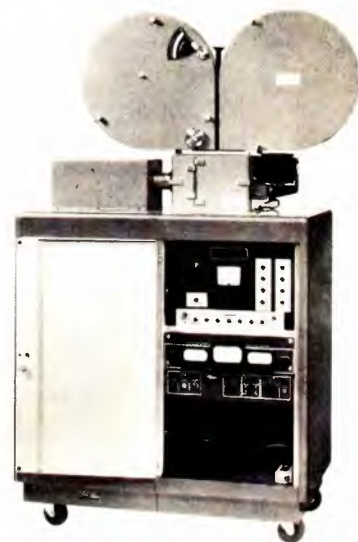

Write for details.

W. A. PALMER FILMS, INC.

611 HOWARD STREET · SAN FRANCISCO, CA 94105
San Francisco's complete 16 mm film service

Circle 117 on Reader Service Card

**Our
new
FM-25KW
and
FM-12KW**

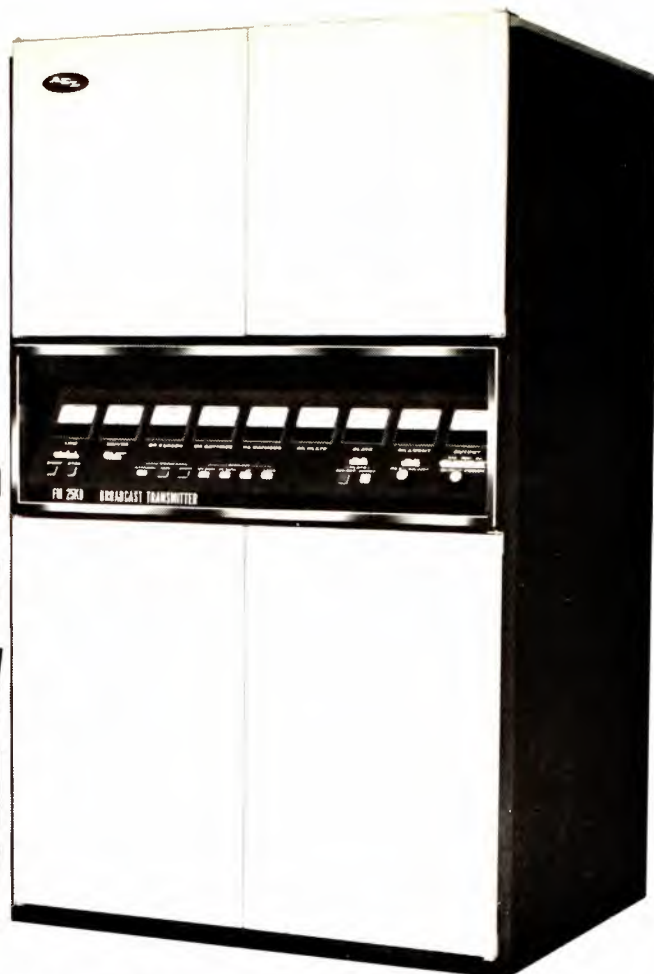

... prove that AEL makes better transmitters even better.

The AEL FM-25KD and FM-12KD Transmitters ... they were better to begin with, but now that we've added an all new, up-dated functional design that makes meter reading easier and operation simpler, they're even better.

These are the ones that feature:

- Full 25KW and 12KW power output
- Two tube design, grounded grid final
- Automatic filament voltage control
 - Automatic power output control
- Solid state control circuitry for improved reliability
 - Designed for automatic operation
- Solid state exciter and power supplies
 - VSWR protection built in



ADVANCED EQUIPMENT LINE

AMERICAN ELECTRONIC LABORATORIES, INC.

P. O. Box 552 • Lansdale, Pa. 19446 • (215) 822-2929

Circle 125 on Reader Service Card

PRODUCTS

Communications service monitor measures the frequency, FM deviation and percentage AM modulation of distant transmitters. The Singer/Gertsch FM-10C, with RFM-10A plug-in, has sensitivity variable from 20 microvolts to 20 mv. and performs the functions of frequency meter, signal generator, and modulation meter for all FM, AM, and SSB applications. It operates from 117 VAC or 12 volt battery, covers 50 KHz to 512 MHz. and has rated accuracy of 1 ppm. \$4225. SINGER INSTRUMENTATION. **285**

Portable digital frequency counter covers 5 Hz to 500 MHz in two ranges, with one high impedance input and one 50-ohm input. Model CM-20R has five digit display (sixth digit optional) with full leading zero suppression. Threshold of the high impedance input can be slid up or down the incoming waveform with a "trigger-level" control. Internal 1-MHz clock signal allows built-in test. Companion model CM-20T has only the high impedance 5 Hz to 15 MHz input. Input sensitivity, 35 to 100 mV rms over frequency range; accuracy, ± 1 count \pm time base accuracy; gate time 1 msec to 10 sec in 5 steps. CM-20R, \$729; CM-20T, \$369. TUCKER ELECTRONICS (American distributor for Analog Digital Research, Toronto, Canada). **286**

Variable focus (zoom) lens for 35mm motion picture cameras has a basic 5:1 ratio, 20mm to 100mm. Cooke Varotal has minimum object focal distance of 13.4 inches to front of lens, with 58-



degree horizontal field. Light transmission factor is 80% (T/3.1 or f/2.8). It is available with manual, servo, and motor drive. RANK PRECISION INDUSTRIES, INC. **288**

Two-way FM radio for land mobile use is available in 50 and 100 watts RF output in low band; 35, 65, and 110 watts in high band; 40 watts in UHF. Mastr II has modular design, can be expanded from one frequency up to eight frequencies with plug-in units, operates in temperatures over the range continued on page 40

Get the professional look from helical-scan Ampex **VPR-7950**

It's that good!

A super-sharp teleproducer can see the superior quality of a VPR-7950 picture compared to one from any other 1" recorder.

What is a VPR-7950?

The world's highest performance 1" color/monochrome, helical-scan videotape recorder. It incorporates the same advanced design features of the Ampex VPR-7900 and the TBC-790 time base corrector in a handsome, highly functional console.

Video waveform and picture monitor selector switches may be used together or independently. An eye-level panel includes both monitors as standard equipment and an optional vector display scope.

The VPR-7950 is a complete recorder/reproducer which features:

- Very high carrier mode (7-10 MHz) for exceptional quality in color dubs even down to 3rd and 4th generations; 5th, in black and white.
- Precision, fast, *total*, electronic insert and assemble editing from any signal source.
- Internal digital reference system that includes a horizontal lock servo, frame lock and vertical interval switching.
- Three independent tracks (single video - dual audio), each of which can be used, altered, edited or replaced at any time.
- High efficiency ferrite video head with 500 hour warranty and the fastest, simplest replacement system ever devised.
- Capstan controlled high speed tape cycling modes, velocity loop tension servo, direct coupled drum servo, minutes and seconds coun-



ter, monitor amplifier and cue microphone.

In developing the time base corrector, Ampex engineers discarded current technology and took a new



*Ampex VPR-7900 recorder/reproducer
with TBC-790*

digital approach to time base correction that affords the most stable video signal ever produced by a helical-scan recorder. It produces clean fades, lap dissolves and special effects as well as dubs of edited material of outstanding quality to 1" and 1/2" videotape recorders, quadruplex recorders and transfers to film.

Like the VPR-7950, the combination of the VPR-7900 and TBC-790 produces recording capabilities that meet all standard broadcast requirements. The TBC-790 may be purchased with the VPR-7900 you may now own. The VPR-7900/TBC combination is portable enough for use as a mobile unit for location work. Tapes made on the VPR-7900 are completely interchangeable with those made on the VPR-7950.

Round out your teleproduction system with the Ampex CC-500 color camera system, which incorporates professional features, is simple to operate and low in price.

CC-500 Camera

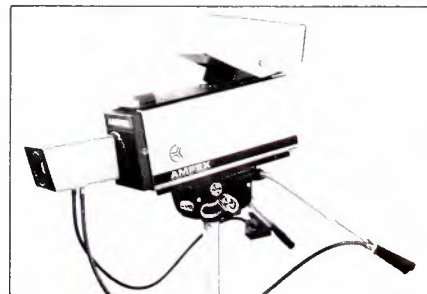

Call your Ampex Dealer or write: Audio-Video Sales, Ampex Corporation, 401 Broadway, Redwood City, CA 94603.

AMPEX

Circle 126 on Reader Service Card

ALL-IN-ONE SPORTSCASTER HEADSET

This sportscaster can roam about a football field, rubberneck at a basketball game, or quickly position himself for an important golf shot. All with just one piece of equipment. The new Telex CS-90 Sportscaster headset lets him broadcast live (fixed station or mobile) listen to production cues, and monitor his own transmission, all with hands free convenience.

He can do all this because Telex has now combined the finest professional microphone available, one of proven broadcast quality, with an equally high-performance headphone.

This wide-range, dynamic, boom microphone has a low frequency response to transmit his voice clearly and crisply, and an omni-directional design to pick up colorful crowd noise. The two channel headphone fits comfortably with a padded headband and foam filled earcushions to screen out ambient noise. It is adaptable to any application or equipment by means of non-terminating cordage and features exclusive Telex audiometric type driver elements. And both headphone and microphone are designed to stand up even if the sportscaster has to work in all types of weather extremes and can't avoid some hard bumps. In fact, if the sportscaster doesn't hold up as well as the CS-90, there is a "push-to-cough" switch that mutes the mike when necessary.

Constructed of high-impact ABS plastic and stainless steel. Styled in non-reflective black and grey to eliminate glare on camera. Write for further information.



PRODUCTS OF SOUND RESEARCH

TELEX®

COMMUNICATIONS DIVISION

9600 ALDRICH AVENUE SOUTH
MINNEAPOLIS, MINN 55420

Circle 127 on Reader Service Card

PRODUCTS

from -40 to +158 degree F, has 12 watts of audio output. Optional is a channel-scanning system that samples each frequency at a high rate, automatically locks receiver on a signal, with instant return to signal on a "priority" channel. GENERAL ELECTRIC Co. **287**

Video compressor puts standard video signals into the audio range, for transmission over dial-up telephone lines. Model 260 also has a 6-bit analog-to-digital converter, may be used as a TV-to-computer interface, for image analysis or industrial control. \$2500. COLORADO VIDEO, INC. **289**

Memory system for "Datacasting" and character-generator units has 250-page or title memory, full keyboard edit, numerical readout for page identification. Model DCM-1 Data Cassette Memory Unit has direct interface with

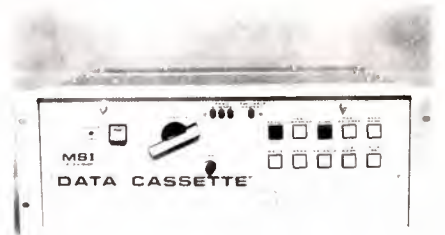

MSI model PT-3200 Production Titler and all MSI Datacasting Systems, automatic sequential access, fast random access. Telephone circuit interface is optional. \$3995.00. MSI TELEVISION. **290**

Coaxial cables for MATV include 12 types in RG-59, RG-6, RG-11, 0.408 in. OD, and special dual twin-braided shield cables for multichannel and two-way systems. Top of the line, #4851, has 100% shielding, 12-gauge center conductor, 1.6 dB/100-foot loss at channel 13 and 3.1 dB/100-ft loss at channel 57. Other types include aluminum tape braid and aluminum tape/braid and aluminum tape/drain wire cables. BLONDER-TONGUE LABORATORIES. **293**

New distribution amplifiers for MATV systems provide 30-32 dB of gain for signal distribution, with greater output and overload capability than units they replace (15% on VHF, 30% on UHF). Model 7330B is all-channel plus FM, with independent UHF section and separate first stages for high and low band VHF. Model 7331B is similar, with VHF FM coverage. 7330B, \$126; 7331B, \$90. CHANNEL MASTER. **294**

continued on page 42

Eight major new products for radio broadcasters in 1972.

MW-50, 50 kW AM transmitter: We threw away the modulation transformer and reactor.



Gateway 80 audio console: 18 inputs into 8 monaural mixing channels; modular solid-state amplifiers, step-type attenuators.



Dualux 80 audio console: Dual programming; 18 inputs into 8 mixing channels.



BC-1H, 1 kW AM transmitter: Solid-state oscillator and audio driver. 125% positive peak modulation capability.

FM-2.5H3, 2.5 kW FM transmitter: Only two tubes for great reliability. An outstanding solid-state TE-3 exciter.



Studioette 80 audio console: 11 inputs into 4 mixing channels. Isolation transformers on all inputs and outputs.

Digital AM frequency monitor: Accurately measures carrier frequency of standard AM broadcast transmitters.



Touch control program automation: Advanced digital design. "Live" sound 24 hours a day.



Leadership means more new broadcast products to serve radio broadcasting.

HARRIS
GATES DIVISION
 Quincy, Illinois 62301, U.S.A

Circle 128 on Reader Service Card

Loaded with Schafer value.



Schafer's new Model RP720-2 professional tape recorder and reproducer provides excellence in craftsmanship and performance at an unbelievably low price. Value-packed features include:

- 3 speeds • Ferrite heads • Positive reel locks
- Hysteresis synchronous capstan motor • Plug-in head assembly • Tape index counter

For details on the remarkable performance-to-price ratio of this new tape recorder, contact Schafer Electronics Corp., 75 Castilian Dr., Goleta, Ca. 93017, (805) 968-8755. In Canada: Schafer Electronics Ltd., 5824 Burbank Rd. SE, Calgary, Alberta, Can T2H1Z3, (403) 253-0351.

schafer Electronics Corporation

Circle 131 on Reader Service Card

Matthey Video Delay Lines



Infinitely variable range of 10-165 ns. in 5 ns. steps, selectable by switches, with fine trim of ± 4 ns by screw adjustment. Cascade with fixed delay boxes of 50, 200, 500 and 1,000 ns. 75 Ω —fully-equalized—insertion loss .1 dB. In service at all three networks, numerous stations.

Price \$75.00 qty. 1-3. Try one at no obligation.

Complete literature and prices on video delays (boxed and PCB modules)—pulse delays—pulse cleaners for under- and over-shoot—low-pass video filters from

Bill Pegler 'phone (516) 628-8068

Television Equipment Associates
BOX 1391 BAYVILLE, N. Y. 11709

Circle 132 on Reader Service Card



\$2,000

... for LPB's **dj5** mini-studio systems, delivered complete and ready for on-air, recording studio or remote operation.

Included are:

- Console.
- 2 Professional 3-speed 12-inch Turntables.
- 2 12-inch Tone Arms.
- 2 Stanton Cartridges, with styli.
- Turntable Equalizer/Preamplifier . . . 2 for stereo.

Nine systems to choose from . . . each with sturdy, handsome, white Formica® top furniture over blue textured finish steel legs and supports.

Other dj5 systems start as low as \$1125. The larger dj8 systems from \$1225.

LPB offers a complete line of broadcast audio equipment. Call or write us for all your audio needs, from microphones to tape recorders.



LPB Inc.
520 Lincoln Highway, Frazer, Pa. 19355 (215) 644-1123
In Canada: P. O. Box 669, Orleans, Ontario (613) 824-3232

Circle 133 on Reader Service Card

PRODUCTS

Indoor splitters and matching transformers for CATV include two-, three-, and four-way splitters with 75-ohm impedance at all ports, cover 5 to 300 MHz. "Pathmaker" series also includes transformers for same range and rating. GTE SYLVANIA. **295**

Time-lapse videotape recorders for surveillance use have 300 lines horizontal resolution, use 7 in. reel of 1/2 in. tape. Model TVR-321-12 (12-hour mode), TVR-321-24 (24-hour) and TVR-321-48 (48-hour) playback at time-lapse speed, normal speed, or still frame. Recordings are standard EIAJ-1 format, playable on any machine of that class. GBC CLOSED-CIRCUIT TV CORP. **296**

Line of **real-time and elapsed time digital clocks** use 60 Hz time base, are accurate to within 3 seconds over any given interval. SSC clock series includes models for 12- and 24-hour range, hr/min or hr/min/sec indica-



tion. ETI elapsed time series includes models ranging from 12 hour to 1999.9 hour coverage. \$95 to \$306. AERO METRIC GENERAL, INC. **297**

RF load resistor handles up to 40,000 watts has self-contained heat exchanger, does not need external water supply. Moduload unit takes 11 cubic feet, terminates 50-ohm systems with VWSR of 1.1 from dc to 1300 MHz. If ambient temperature is limited to 30° C, load capacity goes to 50 kw. BIRD ELECTRONIC CORP. **298**

Rock-cutting wheel, attachment cuts through concrete, coral, shale, or other rocky or frozen surface, up to 4 in. wide and up to 30 in. deep. Vermeer Rock Cutter is attachable to Vermeer M-450 and M-465 trenching units, has a 6-foot wheel with 108 carbide-tipped teeth. 4-speed gear box with safety clutch. VERMEER MANUFACTURING CO. **299**

Dual-beam oscilloscope has sensitivity to 2 mV/cm across full 10 MHz bandwidth. Philips Model PM3232 has no phase displacement between traces (true dual beam), universal triggering facilities, automatic level, dc coupling, automatic TV line/frame selection. continued on page 44

Other editing systems look great on paper. CMX Systems are looking great in editing rooms.

When we introduced the CMX-600 video tape editing system, just about everybody agreed that it was the beginning of a revolution in video tape.

Then we came out with the EDIPRO-300. An editing system that almost any fair sized operation could afford. Because it uses existing VTR equipment to edit tape. And people said that the revolution was in full swing.

As far as we're concerned, the revolution is just beginning. Because in solving the big problems, we've also solved a lot of the little problems. And now we're bringing

those solutions to editing operations. Not blueprints of those solutions. The solutions themselves.

Right now, CMX systems are in full operation. From Los Angeles to London. And by this time next year, you'll be seeing not only a lot more of our present video tape editing systems but several entirely new video tape editing products from CMX. And you'll

be seeing them in editing rooms. So, while you're reading our competitors' projected spec sheets, we'll be providing you some interesting reading on the profit ledger.

see for yourself

Mr. Jerry Hertz
CMX Systems
635 Vaqueros Avenue
Sunnyvale, CA 94086

Dear Jerry:

An editing system that's easy to use? Seeing is believing. Send me everything you've got on the Edipro-300 including the catalog, literature and the system.

Name _____
 Title _____
 Address _____
 City _____



Circle 129 on Reader Service Card

ONLY BROADCAST-TYPE HELICAL VTRs CAN USE OUR DELTA 44 TIME BASE CORRECTOR, RIGHT? WRONG!

That's never been true about the standalone Delta 44, and we've added new accessories to make it even "wronger"! All by itself the Delta 44-N6 is a complete NTSC color conversion kit for older monochrome quad VTRs with H-lock head servo circuitry. It includes monochrome and color time base correctors and a full NTSC proc amp which inserts station sync and subcarrier in the V and H blanking intervals of the processed signal. It resolves 4.4 microseconds of slow and fast off-tape jitter down to ± 3 nanoseconds referenced to station subcarrier, well within FCC specifications for broadcast.

Here's your chance to make an FCColorful silk purse out of your old sow's ear quad VTR, or your Shoat monochrome IVC 900s and 960s and Ampex 7900s, all for only \$10,500.

• New Accessories •

- Delta 28 "TBD"
Time Base Director
- Delta 400 "SYNCLOCK"
Head Servo Drift
Suppressor
- Delta 7 "VELCOR"
Head Velocity Error
Corrector



The Delta 28 TBD and Delta 400 SYNCLOCK units "widen the window" of VTRs which the Delta 44 interfaces to include old mono quads not equipped with "Intersync" or "Pixlock" head servo circuitry, V-locked mono heliscan VTRs made by IVC, Sony, Ampex, Diamond, Craig, JVC... and more...

The standalone Delta 7 VELCOR unit eliminates color streaking caused by head velocity changes in high-band and low-band quad and heliscan VTRs.

Tell us about your VTRs and your video recording problems on the card below. We'll send you details on our DELTA Series hardware solutions, and the name of your nearest distributor who will schedule a spectacular demo on your VTRs.

TO  TELEVISION MICROTIME, INC.

ATTENTION: Marketing/Singles

Exp. name on your mailing list: Product Interest

I have an application in _____ days. Call _____ to get a demo.

My facility is: mono _____ color _____ competing to color, and include: VTR's (describe) _____

My special teleproduction problems is _____

NAME _____ TITLE _____

ORGANIZATION _____ MAIL STOP _____

ADDRESS _____ PHONE _____

T.M. 100 72-1



TELEVISION MICROTIME, INC.
a subsidiary of
ANDERSEN LABORATORIES, INC.

1280 Blue Hills Avenue, Bloomfield, Conn. 06002 • (203) 242-0761 • TWX 710 425 2390

Circle 130 on Reader Service Card

PRODUCTS

\$900. TEST AND MEASURING INSTRUMENTS INC. (PHILIPS). **300**

Distortion analyzer/ac voltmeter has programmability of all functions, ranges and settings. Model 334A-H25 reads total harmonic distortion from 0.1% full scale to 100% full scale in seven ranges. Fundamental frequency range is 10 Hz to 100 KHz; harmonics to 1 MHz are shown. Remote control is by BDC TTL logic; dc output and interrogation circuit allow controller to determine status of instrument. Voltage measurement is from 0.3 mV to 300 V rms full scale, from 10 Hz to 1 MHz. \$3600. HEWLETT-PACKARD. **301**

Remote control system uses relays instead of stepping switch. Model TRC-15A has all relays socketed, and identical for easy maintenance. Operation

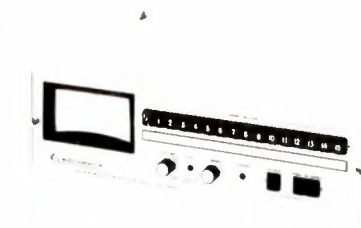

can be by telephone line or wireless; unit supplies 15 metering channels and 30 individual control functions. MOSELEY ASSOCIATES, INC. **302**

Envelope delay measuring system covers 0.1 to 10 MHz for the video modulators and 25 to 250 MHz for the RF modulator. Model 3705 measures delays of ± 30 nanoseconds to ± 1000



nanoseconds in four ranges, with resolution of 2 nanoseconds. Panel meter reads point by point; jack for scope allows sweep display. \$3700. TELEMET COMPANY. **303**

Video waveform/picture monitor combination has 7 MHz bandwidth, is primarily intended for industrial, cable TV and educational users. Model WV-063 has 5 in. monitor screen with 600 lines center resolution, dc restoration and provision for external and internal sync. \$930. ULTRA AUDIO PRODUCTS. **304**

continued on page 46

AUDIO PERFECTION IN CONSOLES FROM WILKINSON

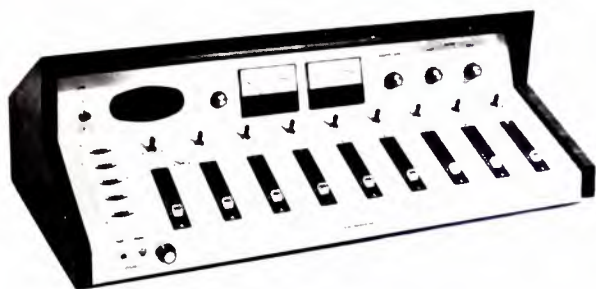

TACS-2C STEREO CONSOLE

FEATURES:

- Modern Formica Design
- 9 Channels
- 6 High Level Stereo; 1 High Level Mono
- 2 Low Level Mono
- 28 Inputs Available

FEATURES:

- Modern Formica Design
- 8 Channels
- 2 Low Level; 6 High Level
- 22 Inputs Available
- Interchangeable High Level Amplifiers



TAC-1C MONAURAL CONSOLE

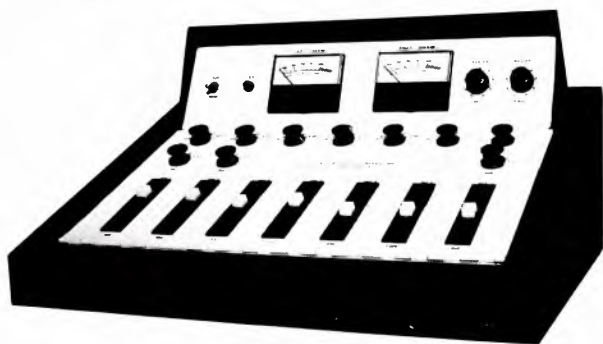

TSC-4 STEREO CONSOLE

FEATURES

- Space Saver Design
- 7 Channels
- 2 Mono
- 5 Stereo
- 15 Inputs Available
- Top Quality Attenuators

WILKINSON
ELECTRONICS, INC.

1937 W. MacDADE BLVD.

WOODLYN, PA. 19094

TELEPHONE (215) 874-5236/874-5237

PRODUCTS

Audio delay device for recording provides either 16 ms or 14 ms electronically produced delay. "Cooper Time Cube" has frequency response ± 2 dB from 40 to 10,000 Hz, distortion less than 1% at program levels to +4 dBm; s/n ratio above 70 dB. UNITED RECORDING ELECTRONICS INDUSTRIES. **305**

Location lighting system supplies up to 5000 watts of quartz lighting, transportable in a lightweight case about the size of conventional attache case. Total-System is completely modular, includes a family of very light and compact support and control accessories. LOWEL-LIGHT PHOTO ENGINEERING. **306**

Crossed planar log periodic antenna can receive dual linearly polarized waves. Model APX1453, with additional components, responds to oblique and circular polarization, is designed for ECM, surveillance, and also for feeds to parabolic dishes. Frequency range: 30-1000 MHz; 3 dB bandwidth, in the E plane, 55°; in the H-plane, 85°; front-to-back, 15 dB; gain, 6 dB. AMERICAN ELECTRONIC LABORATORIES, INC. **307**

Quadraphonic pan pot and channel selector provides switching for channel selection in 16-track recording. Model SML-506094P can make two assignments to the first 8 tracks and two to the second 8, simultaneously. Four pan pots cover the whole 360 degrees, with two concentric controls for left-right and two for front-rear. MCA TECHNOLOGY, ELECTRODYNE DIVISION. **308**

A 5000-watt ring focus 12-inch fresnel mounting is focused by moving the lens rather than the lamp. Filament vibration and shock are greatly reduced; thrust-out relamping allows lamp change without changing fixture position. The unit accepts 5 kw 3200° and 3400° tungsten-halogen lamps. S325. BERKEY-COLORTRAN. **309**

Distribution amplifier with 15-channel output is in rack mounting 1 3/4 in. high. DA-1520 has power supply built in, has transformer input, maximum output and 20 dBm/channel, input, 600 ohms; s/n ratio, 65 dB below 0 dBm; gain adjustable 0 to 40 dB, distortion 0.2% or less. \$295. FAIRCHILD SOUND EQUIPMENT CORP. **310**

High-power RF transformers match 50 ohms to 75 ohms, and vice versa, over

the range from 40 MHz to 250 MHz. The AT-10 series handle up to 10 watts, average power, take 4 cubic inches, have insertion loss of 0.4 dB maximum, VSWR of 1.2:1, use UHF SQ-239 standard connectors. \$39.95. ACRODYNE INDUSTRIES, INC. **311**

Chroma keyer works with special effects generator to provide keying effects based on hue from an encoded composite video signal. Model VK-2140 can be incorporated into a production switcher with multiple effects systems without external key delays. A hue enhancement technique reduces noise, improves resolution, and bars spurious luminance transient effects. CENTRAL DYNAMICS CORP. **312**

Video routing switcher has ten inputs, ten outputs. Model 1060 frequency response is ± 0.5 dB from 30 Hz to 10 MHz, crosstalk 70 dB down at 3.58 MHz, differential gain and phase at 0.5% and 0.40 respectively. It includes BCD control logic and power regulation. Switching can be direct, preselect, or computer control; display can be illuminated push buttons, digital read-out, or plain language (illustrated). VISCOUNT VIDEO SYSTEMS LTD. **313**

World's standard
FREZZOLINI

"Frezzi-Cordless"
professional
16mm TV
newsfilm
single/double
system sound
cameras



Supplied with Angemonts 32 120mm. 1000 ft. and V. 4000 ft. and 1000 ft. with TV remote. Optional: Special TV Newsfilm Package, complete with choice of camera, including with film, and portable Frezzi Unit. For consultation about TV newsfilm camera requirements and for camera demonstration call or write James L Crawford, Vice Pres. Engineering.

Model 800NC
Light
weight
high-
energy
nickel-
cadmium
powered
BATTERY
PACK



General Research Laboratories  Frezzolini Electronics Inc.
7 Valley St., Hawthorne, N.J. 07506
PHONE: (201) 427-1160

Circle 135 on Reader Service Card



**FIVE MIXER
AUDIO CONTROL**

B-500 series
the B-501 monaural
\$750
the B-502 stereo
\$1050
B-503 dual channel
\$950
the McMartin
full choice line includes
the rack mount
ACCU-FIVE
mini-console, and
the eight channel
B-800 series
for complete information
please contact
the Director of Sales
Dept. B-50

McMartin
McMartin Industries, Inc.
605 North Thirteenth Street
Omaha, Nebraska 68102
(402) 342-2753 Telex 048-485

Circle 137 on Reader Service Card

consoles

RAPID-Q™ 3000

CARTRIDGE TAPE EQUIPMENT

- RAPID-Q Adjustable Delayed Automatic Fast Forward Standard
- Modular Independent Units Single, Dual, or Triple Cases
- Rack or Desk Top Mount
- Superior Performance
- RECORD ■ PLAY ■ MONO ■ STEREO MODULAR UNITS



RAPID-Q 1216 KIFER ROAD SUNNYVALE, CALIF. 94086
(408) 736-8737

Circle 136 on Reader Service Card

All that comes between tape and film is one thin electron beam.

Now 3M meets your needs with color as well as black & white electron beam recorders. Each machine produces the finest tape-to-film transfers possible by eliminating the image-degrading elements of conventional kinescope systems.

With the 3M electron beam technique, the video signal controls an electron beam that exposes an image directly on film. No phosphor, no faceplate, no camera lens come between video input and the film. Thus, there is no degradation of image quality. As an additional benefit, the

high energy of the electron beam permits the use of an economical, slow-speed, fine grain film. The electron beam technique may be used for producing high quality black & white films or three-color separation masters. The result is high contrast 1,000-line resolution images.

In the color electron beam recording system, the black & white separation master has archival storage life with no possibility of color fading or hue shift. This master is then printed onto 16MM (35MM option) inter-

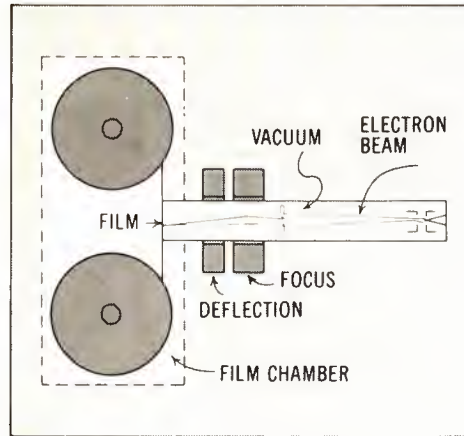

negative film in an optical step printer.

The internegative film is then used for conventional, high speed contact printing techniques. The resultant release print contains true saturated colors, no color crosstalk or fringing, accurate color convergence and balance, and precise registration and exposure. This film is free from splicing, shutter bars, or similar frame rate conversion anomalies.

The black & white electron beam recorder exhibits analogous performance characteristics in the transfer of black & white video

material. The flipping of a switch allows the recording of either positive or negative images without a change in film stock.

For video tape-to-film transfers as close to perfect as you can get, insist on 3M's color or black & white electron beam recorders. For more information, contact Electron Beam Products, Mincom Division, 300 South Lewis Road, Camarillo, California 93010. Telephone (805) 482-1911 Ext. 411.

3M presents the ideal tape-to-film transfer equipment: color and black & white electron beam recorders.



ELECTRON BEAM PRODUCTS
Mincom Division **3M**
COMPANY

Spotmaster

The Top Turntable



... is Spotmaster's new Studio Pro B, offering instant start and the tightest cue potential in the industry. Heavy duty hysteresis motor drives a 6½ lb. machined aluminum platter in a solid-cast aluminum chassis for inaudible rumble, lowest wow and flutter. Indicator lights tell speed (33 or 45) at a glance, and speeds can be changed with platter in motion. Detachable mounting plate (accepts any tonearm), integral 45 spindle and neutral cue position are other features . . . all for just \$198.00.

And an Outstanding New Tonearm

... is the Spotmaster stereo BE-402 (mounted on Studio Pro B above), which combines reasonable cost, rugged design and professional specs. Features include high compliance for modern stereo cartridges, minimum tracking error, anti-skating, low mass, quick-change head, easy single-hole mounting . . . for only \$54.95

Complete line of Gray professional arms and all broadcast quality phono cartridges also available at competitive prices.

And the Best Turntable Preamp



... is our new Model TT-22, all solid state, modular, stereo equalized and completely self-contained. Features separate balance/level controls, high output (+8dbm), phone jack . . . plus switchable and removable rumble and scratch filters. Both stereo and mono models are available, starting at \$121.50. Our time-tested TT-20B mono preamp and PR-4C power supply (will power up to 4 preamps) are also available, providing top performance at economy prices.

... all from Spotmaster

PLUS a complete range of accessories for both turntable and cartridge tape operation. Write for details.

BROADCAST ELECTRONICS, INC.
A Filmways Company

8810 Brookville Rd., Silver Spring, Md 20910
(301) 588-4983

NEWS continued from page 12

N.Y., as exclusive sales representative for the EECO videotape editing equipment . . . **RCA** sold about \$1 million in color videotape equipment to Venevision, Venezuelan TV network, which is preparing studio facilities for color broadcasting, expected to be authorized soon in that country . . . **Cox Broadcasting Corp.** announced sales of \$55,905,000 and net income of \$7,091,000 for the nine months ended September 30, 1972, up from \$46,467,000 and \$5,757,000 in 1971.

Ampex Corporation announced that the 42 Ampex VTRs used to aid in television coverage of the Olympic games in Munich had been sold to customers around the world, including stations and production centers in Canada, The Netherlands, Great Britain, Sweden, France, Spain, West Germany, and the U.S.

Sony Corporation will make more than 100,000 U-Matic Videocassette machines in 1973, Harvey L. Schein, president, told the convention of the National Association of Educational Broadcasters.

People

Frank Benson became manager of broadcast sales, and **Thomas R. Meyer** became product line manager of broadcast and automated systems, both for TeleMation, Inc., of Salt Lake City . . . **Eric M. Berndt** got the Eastman Kodak Gold Medal; **George R. Groves** received the Samuel L. Warner Memorial Award for improvements in sound recording; and **Peter Rainger** of the BBC got the David Sarnoff Gold Medal for contributions to television technology, all at the SMPTE meet in Los Angeles in October.

Warren L. Anderson was appointed merchandising manager for video products at Sony Corp. . . .

Perry L. Schwartz is the new director of engineering for Gridtronics, Inc., a subsidiary of Television Communications Corp., developing systems for delivering motion pictures to cable subscribers . . . **Irving Rabowsky** was named chief engineer of Theta-Com's AML division.

Walter Hinchman, formerly assistant director of OTP, will be head of the FCC's new Office of Plans and Policy . . . **L. I. Decker** will be vice president—engineering of Suburban Cablevision, subsidiary of Suburban Propane of Whippany, N.J., and operator of nine cable systems on the East Coast . . . **Art Freeman** became production man-

ager of Kaiser station KBHK-TV in San Francisco . . . **Wallace Anderson**, manager of TPT's cable system at Jamestown, N.Y., was elected 1972-73 president of the N.Y. State Cable TV Association.

Calvin A. Watson was named director of television activities and **Thomas C. Warnock** director of radio activities, both for the Corporation for Public Broadcasting . . . **Keith Moon** became station manager for KSBW-TV, Salinas, Calif.

BM/E

THE LEADER IN CATV TOWERS

"Quality—Service and Price!"



Yes, quality, service and price on CATV systems are the reasons for Fort Worth Tower's position as the industry's leading supplier. Experience gained as a pioneer supplier of CATV enables Fort Worth Tower to provide you with a quality product at a price that is reasonable and attractive.

Take advantage of our experience. For assistance in systems planning, engineering and complete systems quotations . . .

CALL OR WRITE TODAY

Fort Worth Tower

COMPANY, INCORPORATED

P.O. Box 8597, Fort Worth, Texas
(817) JE 6-5676

—Associated Companies—
Tommy Moore, Inc.
Big State Engineering, Inc.
Tower Construction Finance, Inc.

Circle 139 on Reader Service Card

FASTEST HANDLING SINGLE SYSTEM SOUND CAMERA IN THE WORLD.

Canon Sound Scoopic 200. A single system sound-on magnetic news documentary camera. Designed for the TV news cameraman. Without compromise. And with features long demanded . . .

REFLEX VIEWING through a 135° rotating mirror shutter. No beam splitter. **No loss of light at the film plane.**

FULLY AUTOMATIC THRU-THE-LENS METERING with manual override control. F stops visible in the viewfinder. Instant open and return diaphragm for fast focusing.

FILTER SLOTTED 12.5-75mm Canon zoom lens. Filter changeable in seconds.

REGISTRATION PIN MOVEMENT. Assures perfect framing.

ELECTRONICALLY GOVERNED MOTOR. Insures accurate sound speed.

MODULAR TWIN SOUND HEADS. Snap in and out in seconds.

LIGHT WEIGHT. 12 lbs. 6 oz. Including body with film chamber, lens, exposure system, sound heads and take-up spools.

LOW PROFILE bottom load design for 200 feet daylight spools. Shoot from cars, doorways . . . anywhere.

AND MORE. A 6 lb. 14 oz. over-the-shoulder amplifier/camera power pack in a single unit. With advanced automatic gain control with manual override. VU meter. Dual mike input. And a fast rechargeable battery that powers the camera, meter and amplifier through 2000 feet of film. Recharges in under 5 hours. Batteries interchange in seconds.

Feature for feature, Canon Sound Scoopic 200 adds up to getting the news faster than ever. See it in action at your Canon dealer. Or write us for more information.



New New New
Come out of the dark with great shots!
We've widened our rotating mirror shutter angle from 135° to 170° for more direct light to the film. And we've changed the lens opening from 2.5 to 1.8. Now you can shoot in much darker areas than ever before.
At Canon we make good things even better.

Canon
SOUND SCOOPIC 200
Canon USA, Inc.
Nevada Drive, Lake Success
New York 11040

NEW LIT

For copies of these literature offerings, circle number for appropriate items on Reader Service Card.

Data sheet covers **overhead directional taps** for 5 to 300 MHz, with values ranging from 7 dB to 25 dB, two and four outputs. Magnavox CATV. **201**

Ten different blank forms for cable TV equipment logging provide sys-

tematic documentation of test and performance, from antennas through to receivers, as an aid to maintenance and in anticipation of FCC technical requirements. Ameco. **202**

Magnetic heads for studio use are shown in new catalog, including 4-channel for 1/2-in. tape, 8- and 12-channel for 1-in. tape, 16- and 24-channel for 2-in. tape; with full technical descriptions. Nortronics. **200**

Catalog describes correspondence courses for TV service technician, electronics technology, and FCC radio-telephone license programs. International Correspondence School. **203**

Solid-state component line, including high-frequency transistors, VIG-tuned oscillators, thin-film MIC-amps, etc., plus discrete component wideband amplifiers for ranges from 1 KHz to 6 GHz, are covered in 16-page catalog. Avantek Inc. **204**

"Who's Who in Electronics," lists **10,000 electronic suppliers, 3500 reps, 3000 wholesalers**, arranged by region, with addresses and telephone numbers of national and local sales offices. Regional edition, \$20.50; national edition, \$49.50. Harris Publishing Co. **205**

Catalog of 56 pages lists complete line of **plugs and jacks, connectors, alignment tools, clips, binding posts, terminal strips, etc.** National Tel-Tronics. **206**

Twenty-page technical brochure describes **communications service monitor, Model FM-100**, which covers 50 KHz to 500 MHz, together with extensive application notes, description of several plug-in options, complete specifications. Singer Instrumentation. **207**

Folder contains data sheets on **complete line of SCRs and related silicon devices**; also more than 20 sheets, each describing a new design idea utilizing SCRs, such as interval timer, high-level readout, high power control, etc. Unitrode. **208**

SMPTÉ edit code is given full description in booklet, with application notes and listing of hardware devices—generators, readers, etc.—which use code. Electronic Engineering Company of California.

Vidicons are described with technical specifications in new leaflet. English Electric Valve Co. **209**

New 72-page catalog shows broad line of switches and keyboards, with drawings, specifications, and application notes. Cherry Electrical Products. **210**

Phono arms, turntables, preamplifiers, loudspeakers, for broadcast use are covered in catalog. Micro-Trak (formerly Gray Research). **211**

A guide to line voltage regulation shows broad selection of Variac regulators, with detailed application information. General Radio. **212**

Detailed data sheets on **plumbicon camera tube series**, with all mechanical and electrical specifications, have been issued. Amperex Electronic Corp. **213**

Harvey promises you... One touch and it's a Fade Accompli.

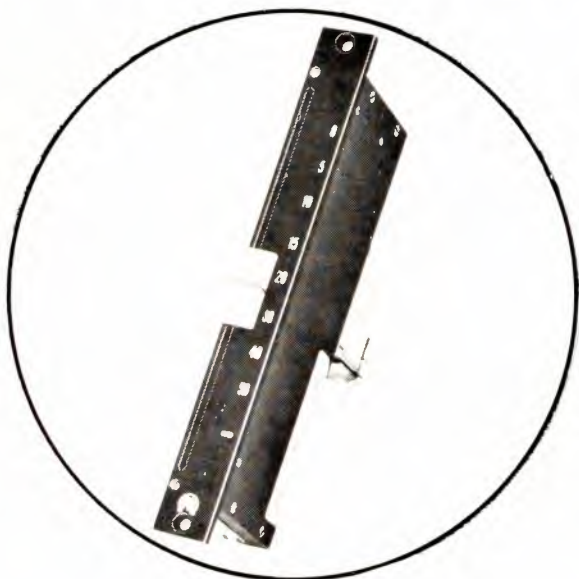

Console photo courtesy of Rupert Neve & Company Limited utilizing Penny & Giles faders.

Penny & Giles faders are incomparable! They're linear motion studio faders which fade so smoothly, so noiselessly, with so little effort that a touch is all that's needed for a perfect fade.

Their incredible smoothness, infinite resolution and absolute freedom from noise come from advance-design mirror-finish conductive plastics, silently wiped by multi-finger precious-metal wipers.

Available in standard (1.5" width) or the new thinline (.75" width) dimensions, the Penny & Giles faders come complete with knob, mounting plate, fascia plate and connector.

The lifelong reliability and dependability of Penny & Giles faders comes from years of experience achieved in the exacting world of

avionics. The full details of Penny & Giles studio faders come when you send in the coupon. So why not send it today? Harvey's delivers what it promises!

Please send me the facts on Penny & Giles linear motion studio faders.

Name

Company

Address

City State Zip

Harvey radio

PROFESSIONAL AUDIO VIDEO DIVISION
444 Madison Ave., New York, N.Y. 10022
(212) 582-1500 • (212) 832-8675

CROSS-TALK

Editor, *BM/E*:

I read with interest the article on TV Automation Systems in the September issue of *BM/E*. I was disturbed upon reaching the conclusion that you completely omitted any reference to the first integrated technical and business TV automation system in the world. This system has been in operation at WNEP-TV in Scranton since the beginning of the year.

In that system, a single mini-computer (the GE PAC-30) located at the station performs all of the real-time tasks of the CDL APC-610 and all of the business functions of Cox Data Systems, except for invoicing and accounts receivable. In lieu of these, it outputs a daily as-run-log tape for an IBM-360 with all of the details needed for billing and a dollars aired summary. Because this system is completely contained at WNEP, the data is available at a much higher rate than remotely located computers with the slow telephone line interconnections. Printed reports are available at 300 lines per minute while CRT inquiries are displayed at 960 characters per second.

The WNEP automation system was a lifesaver for the station during Hurricane Agnes and its aftermath. With a large portion of Wilkes-Barre under water, the station lost half its staff and many of its advertisers for several weeks. The computer enabled the station to air its normal programs and, at the same time, cancel ad contracts advertisers didn't want (stores closed because of the flood) with only half the staff. This would never have been done with the original manual operation paperwork system. It is significant to note that two of the employees missing were the traffic manager and the sales secretary, the two key operators of the business automation portion.

The reason that station operations continued normally was that the system is designed so a single entry in the contract file automatically updates all associated files, program schedules, etc., and no paper work is necessary in the system. Besides single entry additions and deletions, the computer automatically assigns machines and performs rotations so the operation is completely "hands-off" in master control, the only operation being loading machines. Referring to your cover, WNEP's master control has no monitor for inputs, but only off-air

demod, program feed, and preview monitors the computer did take over! Since the system has been in operation, there has been a dramatic reduction in on air discrepancies except for the unavoidable such as film breakage.

... Another interesting automation system has been in operation since the first of the year at Pennsylvania Public Television Network in Hershey, Pa. Their system performs real time and on-line tasks except that instead of a single output, the computer controls three different programs being fed simultaneously to up to 18 differ-

ent outputs. The conflict and error checking algorithms are eight times more complicated on the PPTN system than other TV automation systems presently in use.

You might also have given credit to the forerunners of computer automation systems, for their "lumps" helped the present systems to bypass a lot of hurdles, e.g., the first mini-computer automation at KMOX, St. Louis, and the switching system being run with a 360 on the coast.

George F. Eustis, Jr.
Intercollegiate Broadcasting System,
Syracuse, N.Y.

continued on page 52

ask about our new am | fm | tv monitors



Call or Write ARNO MEYER

BELAR ELECTRONICS LABORATORY, INC.

Delaware & Montrose Avenues, Upper Darby, Pa. 19084 Box 83
(215) 789-0550

Circle 142 on Reader Service Card



TR-E2 FM/SCA EDUCATIONAL RECEIVER

a moderately priced
crystal controlled
sca receiver
designed specifically
for educational
broadcasting and
services to the blind;
a product which
reflects McMartin's
recognized multiplex
experience.

McMartin SCA RECEIVERS

McMartin Industries, Inc.
605 North Thirteenth Street
Omaha, Nebraska 68102
(402) 342-2753 Telex 048-485

Circle 143 on Reader Service Card

Spotmaster

TP-1B Tape Cartridge Winder



This rugged and dependable tape winder fills a need in every station using cartridge equipment. No longer is it necessary to restrict your cartridge operation to stock sizes, or to tie up your conventional tape equipment loading cartridges. The TP-1B handles all reel sizes (up to 3600' of 1 mil tape), winds new or old cartridges in any length. Available with or without Spotmaster tape timer, providing precise minute and second calibration for creating exact-length tapes. TP-1B is \$104.50, with Tape Timer \$129.50. Lubricated tape and empty cartridges are also available.

BROADCAST ELECTRONICS, INC.
A Filmways Company

8810 Brookville Rd., Silver Spring, Md. 20910

CROSSTALK

And for one more round (we hope the last, for a while) on the cartridge quality problem, here are two more letters, one from a cart maker, one from a cart user:

Editor, BM/E:

I wish to take issue with a few concepts presented by the author, Mr. Grady Moates, in "Solve The Cart Problem With Instant Alignment" (November *BM/E*).

Although I strongly support your concept of presenting economy-oriented ideas for the stations in smaller markets, there are times when it is better to suffer with a problem until the necessary funds are available.

Figure 3 of the article shows the guides "bending" the top edge of the tape from a supposedly defective tape cartridge. I have found that if the guides are correctly adjusted, rarely is this so-called "bending" process experienced during the recording of program material onto all but the most defective cartridge. This is, of course, assuming that the tape guides are correctly installed with regard to

azimuth and zenith. With the use of a colimeter, the heads can be correctly aligned in the three planes (azimuth, zenith and height), and the entire assembly will accept almost anything.

I further disagree with the author's conception that operators are competent to adjust head alignment. The human ear is not the most precise instrument in the engineer's tool collection.

The author fails to recognize that with tape head azimuth alignment, it is virtually impossible to make any adjustment that does not affect height and zenith. Thus, this procedure should be left to those who know what they're doing.

I would recommend that the \$15 that the project costs be applied to new cartridges.

David P. Hebert
Chief Engineer
Station KXRO

Editor, BM/E:

It would appear from the letters you have received that magnetic tape cartridge manufacturers are being charged with all the stereo broadcasting technical problems. Perhaps there is another view.

Everyone in the tape cartridge industry wants to improve per-

formance. That includes manufacturers and users, and they've been pretty vocal about the enormous precision required to service recorded stereo systems. It's fair to assume that all machine and cartridge designers are aware of the problems and that they put massive effort into product improvement. Broadcasters have furiously tried each new cartridge as it was introduced. In many instances the user found he had sharply different needs than the cartridge was designed to supply. The shakeout continues with the user in control.

We (at Fidelipac) probably have as many far-out designs for cartridge improvement as has any cartridge manufacturer. We've learned the hard way that our products must not require major changes in our customers' equipment and must not force him to go through unreasonably elaborate alignment rituals.

It is astonishing how difficult it is to obtain standard alignment tapes. Few of our customers use them regularly. Each is almost forced to develop his own alignment standard and do his best to maintain it using locally made tapes. And this situation is further complicated by the flood of instructions they receive, some of

continued on page 54

Ever feel like the White Rabbit on his way to the Mad Hatter's tea party?

Any broadcast station runs on a tight schedule. In fact, your clock may be the most important piece of equipment you have. And lots of clocks aren't everything they could be. So lots of stations end up worrying about the time. Just like the White Rabbit.

That's why we've developed the DIGIT-SYNC™ Clock/Timer System. It keeps all your clocks on time and synchronized. Real or lapsed. On a 12 or 24 hour format. And it never loses more than three seconds per year.

The DIGIT-SYNC Master Clock synchronizes impulse clocks, 60-Hz clocks, event timers, station breaks, programs, and as many of its own digital or round faced slave clocks as you need. An optional built-in character generator is available. In fact, the modular design of the DIGIT-SYNC System allows you to expand it from a single clock to a clock system of virtually any size or complexity.

The only thing you don't get with the DIGIT-SYNC System is a lot of complicated wiring. Time data and power supply are transmitted by built-in modems via a single pair of shielded wires. Time information can be recorded on your tape recorder.

And, incidentally, if the power fails, it switches to an external battery. Automatically.

So if you're in a time bind, don't be a White Rabbit. Get a DIGIT-SYNC Clock/Timer System or arrange for a demonstration.

TFT TIME & FREQUENCY
TECHNOLOGY INC.

2950 Scott Boulevard, Santa Clara, California 95050 (408) 246-6365

Circle 144 on Reader Service Card



automatic

VTR editing system

a precision tool for creative people



Only the Central Dynamics PEC-102 offers all this:

- Computer control
- CRT readout with mimic display
- SMPTE time code
- Video production interface for complete effects control
- 600 scene mass storage file (optional)



CENTRAL DYNAMICS LTD

CANADA-147 HYMUS BLVD., MONTREAL 730, QUE
U.S.A.-230 LIVINGSTON ST., NORTHVALE, N.J. 07647

Circle 145 on Reader Service Card

PERFECT YOUR CCTV SYSTEM WITH **COSMICAR**® LENSES



TV-COSMICAR-EE 16mm F/1.6

The TV-COSMICAR-EE 16mm f/1.6 is a high-speed EE lens specially designed for 2/3" vidicon cameras. It maintains image luminance 100 lx against subject brightness between LV11.3~17 (350~18,000 cd/m²), about 1,800~96,000 lx.

The automatic electric-eye diaphragm close down completely provided that subject brightness exceeds approx. LV20 (144,000 cd/m²), 768,000 lx. In case the camera is switched off and not in operation, the automatic diaphragm closes down, completely shutting off the light for protection of the vidicon camera.

The "Change-over Switch" in front of the lens controls the operation of the diaphragm.

When the switch lever is turned on to "EE", the lens diaphragm operates as fully automatic electric-eye, and is brought on to "OPEN", the diaphragm stays fully opened condition.

Be sure to get the finest image recording results with quality Cosmicar lenses.

Also available are scores of other lenses, ranging from 8.5mm to 1,000mm telephoto, zoom and those motordriven among them, for immediate delivery, after being tailored to your specifications.



COSMICAR OPTICAL CO., LTD.

424, Higashi-Oizumi, Nerima-ku, Tokyo, Japan

Cable Address: "MOVIEKINO TOKYO"

Circle 146 on Reader Service Card

CROSSTALK

which, if followed under standard conditions, will degrade reproduction rather than improve it.

We have many good customers broadcasting high-quality stereo with good mono. Because the authorized stereo system is sensitive to incredibly small timing errors, it is the broadcaster's master touch that hones his system to its sharpest performance. Remember too, that many reel-to-reel and disc systems are strained to reach full stereo compatibility. But it's get-

ting easier. Everybody's working on it.

Charles L. Townsend
Chief Engineer,
Fidelipac

We stand corrected by the following letter from Robert Stengel of NCTA, on the question of the cable operator's responsibility under the fairness doctrine for public access channels. In the October issue, we said he had it: Mr. Stengel says no, and our Washington attorneys agree. Cable operators should, therefore, read the letter carefully:

Editor, BM/E:

I'd like to point out what I think is

an incorrect interpretation in the October issue of the rules with respect to the "fairness doctrine" requirements on the access channels. On page 16 you write:

"All of these channels will engage in "origination cablecasting." In short, the CATV operator is given the responsibility to prevent the violation of the Fairness Doctrine on all of these channels. At the same time, he is prohibited from exercising program control. To insure fairness, without the authority to do so, seems like a very unfair burden for a CATV operator to meet."

But in paragraph 145 of the Cable Television Report and Order the Commission says:

"The access requirements we are imposing differ considerably in scope and purpose from our origination requirement of Section 76.201. Because of the system operator's control over programming of originated material it was necessary to impose such obligations as are involved in the "equal time" and "fairness" doctrines. *Such requirements are not being imposed on the use of the access channels because these channels are free of operator control and access is guaranteed.*" (Emphasis added.)

Robert Stengel
Director, Public Affairs, NCTA

Editor, BM/E:

Your August issue on automation was most interesting.

Automation manufacturing has been Autogram's primary business since 1968. Collins Radio has represented Autogram since 1969.

Oddly enough, the August "Automation Issue" did not list Collins Radio or Autogram as manufacturers. If your publication is subject to the same control and regulations that radio stations are currently receiving, we feel we're entitled to "equal time."

James D. Jelley
Autogram

Editor, BM/E:

I read with great interest the article "All You Ever Wanted to Know About Production—Just Ask," part 9 on Studio Lighting by Douglas Gratton in your September issue. We appreciate and are flattered by the plug for our Lighting Handbook—Fourth Edition for Television, Theatre, and Professional Photography. I would, however, like to clear up one very gross error . . . Century Strand is anything but a competitor. They are a very close working friend; after all, you have to have "the light" into which you put "the bulb." GTE Sylvania makes only the bulbs.

James L. Davis
GTE Sylvania

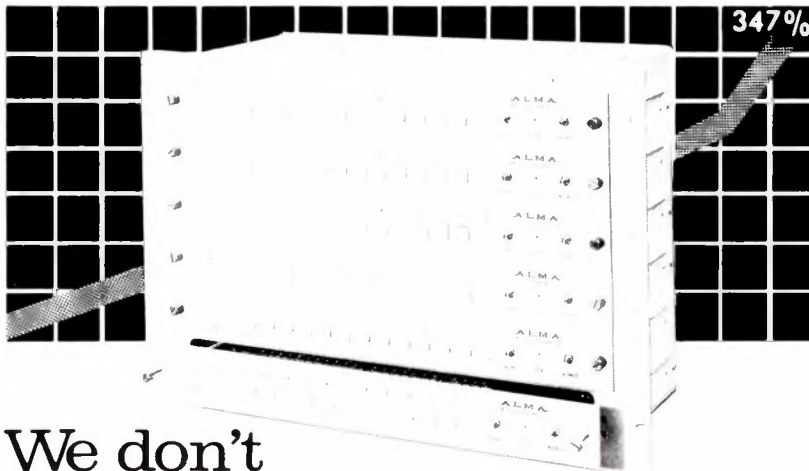

We don't
mind admitting...
it took some time...

. . . hours of sales talk (by telephone and in person) . . . a ton of literature . . . spec after spec after spec . . . but . . . our 8500 Series Routing Switcher sales are booming. Sales are up 347% over 1969, an indication that all the time, talk and promotion was effective. So effective that we don't mind admitting it took some time!

Our enthusiastic customers agree — Alma's 8500 Series locally-controlled routing switchers are the most versatile on the market. With either 6 or 12 looping inputs and three basic frame configurations (one, three, or six busses) that can be stacked and looped to provide any number of outputs, expandibility is unlimited.

Standard features include illuminated pushbuttons, two isolated video outputs per channel, all solid-state construction, and test points and video level adjustments on the front panel. Audio follow switching and amplifiers, sync addition and clamped outputs on each buss are optional.

If you haven't spec'd an Alma Routing Switcher in your system, call our nearest distributor — or write us:

Alma Engineering, Inc.
7900 Dagget Street
San Diego, California 92111

Circle 147 on Reader Service Card

internally as to the line. As we're demonstrating, we have the VITS signal, the color bar signal, on line 18 of both fields, and the VIRS, or vertical interval reference signal, on line 19. By means of the VIRS signal, differential gain, differential phase, and video level can be checked at any point throughout the transmission system from the point of origin to the point of final transmission. We feel it's desirable to introduce this signal at the earliest possible point in the system. This is important over long-line or trans-continental transmissions, as well as to the broadcaster himself, who is equally interested in having a known reference signal throughout his own plant. So if each camera produces a fixed, known, and dependable reference signal, he can then use this as a means of checking performance on a continuing on-air basis in his own plant.

Sounds good. Does that about cover it?

There are a couple of other points about the encoder that are quite significant. One is the residual subcarrier performance. This has been the most difficult stability problem in encoders since day one. Even today, to my knowledge, all encoders have specified subcarrier rejection levels in the order 40, 45 or 50 dB, and limited their specification to $\pm 10^{\circ}\text{C}$ from the temperature at which it was adjusted. In other words, the manufacturer could not specify the stability over any temperature range—or for any drastic

change in line voltage or time. In other words, they're prone to drift.

By using digital switching mode modulators and a unique clamping system, we eliminate such errors each horizontal line. We can specify 55 dB carrier rejection from 0° to 60°C , from 100-130 VAC line voltage, and maintain actually closer to 60 dB in practice with no adjustments, or automatic carrier balance controls, all as a result of this digital design.

Is residual subcarrier that much of a problem? Is it noticeable?

It's a very serious problem. It means that if the scene goes black, you should have no subcarrier present. If there's no color information there should also be no subcarrier. If there is residual subcarrier, it will show up in the picture as extraneous subcarrier that detracts from the the picture viewing on either monochrome or color sets.

The other feature I'd like to mention is the construction. The entire encoder is in one drawer, with a plug-in umbilical that permits its complete removal in a matter of seconds.

Well, that leaves just price to talk about.

The encoder offers stability and allows a broadcaster to upgrade an older camera to meet the performance specifications of the most modern cameras. The cost of the encoder is \$4295 for the basic machine, with an additional \$500 for the VITS/VIRS option, and \$200 additional for the remote control panel. **BM/E**

FIDELIPAC[®] Automatic Tape Cartridges



... the standard of the industry for quality, durability and flexibility are now obtainable world-wide. Available in three size configurations:

- ▶ Model 300, in lengths to 10½ minutes @ 7½ ips
- ▶ Model 600, in lengths to 16 minutes @ 7½ ips
- ▶ Model 1200, in lengths to 32 minutes @ 7½ ips

Heavy-duty tensilized Polyester Tape used throughout. Compatible with all standard Broadcast Cartridge Recorder-Reproducers. Over 25,000,000 now in use.

For complete information and the name of your nearest Fidelipac[®] Automatic Tape Cartridge Distributor, contact

FIDELIPAC[®]

3 Olney Avenue, Cherry Hill, New Jersey 08034 U.S.A.
Telephone: 609-424-1234

Fidelipac is a registered trademark of Telepro Industries Incorporated

Circle 148 on Reader Service Card

REMOTE TRANSMITTERS cont'd from page 23

as A and B alternately transmit, the receiver automatically switches from one channel to another.

At other times, when pickup of weather news is required, the receiver locks up on the weather channel and the audio output of the receiver can be fed



To give portable units greater range, and thus more flexibility, an RF power amplifier and roof-top antenna can be installed in a vehicle with the hand-held transceiver pluggable into the power unit (this one is made by Motorola).

to the studio for immediate rebroadcast or taping.

When reception of the weather channel is not wanted, the switch for the weather channel should be set to the off position. If left in the on position, the receiver will stay locked on the weather channel because the weather station's carrier is transmitted continuously and the scanning action is stopped.

The audio output of a monitor receiver is usually fed to a 3.2-ohm self-contained speaker. Some also have a headphone jack. To enable both aural monitoring and feeding of the AF signal to the audio mixer, the circuit shown in Fig. 7 can be used. The internal speaker is disconnected and fed through T1 which is a Mix-n-Match transformer. Level is controlled with variable T-pad R7. The AF output of the audio mixer is fed through T2, a 4-ohm to line transformer. The level is set as required by fixed T-pad R2.

To improve the received signal

At the receiver location, the antenna should be as high as possible above the ground and should be fed through foam-filled or air-dielectric coaxial cable. If adequate antenna elevation is not readily attainable at the studio location, the receivers and order wire transmitter may be installed on the roof of a tall building or a hilltop, with leased wire lines run to the studio.

The problem is not transmitting to the portable units, but in receiving from the portables. In some

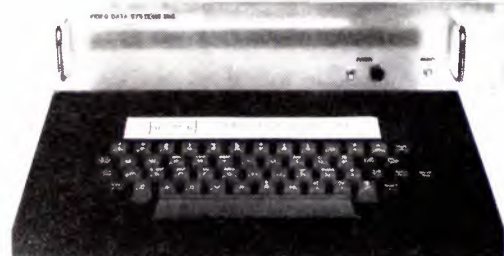

LOW COST COLOR CHARACTER GENERATORS

Centron series character generators permit display of newswires and stockwires in full color, with 32 easily readable characters in 8 or 16 line formats.

Titling Devices

Model CG104 — Adds titles to studio program video signals. Available with internal (RS-170) synch, or will accept studio synch, built in magnetic tape interface.

Information Displays

Model CG101 — Newswire Input

Model CG102 — Stockwire Input

Multiple Input Systems

Model CG201 — Newswire and local information from electronic keyboard or magnetic tape.

Model CG301 — News, stock and local.

PRICES START AT
\$995

Call or write for detailed literature.



Video Data Systems, Inc.

34 Sylvia Road, Plainview, N.Y. 11803
Tel 516 938-1074

Circle 149 on Reader Service Card

accurate measurement of the fourth dimension

Standard Electric Time has developed and manufactured units for the precise measurement of elapsed time since 1932. These panel mounted or portable units are available in several models with accuracies to plus or minus one millisecond. They can be connected to electrical or electronic circuits for remote start, stop and reset.

For full details request catalog 261.



PANEL MOUNTED



PORTABLE

Model	Scale Divisions	Totalizes	Accuracy
S-100	1/5 sec.	6000 sec.	±.1 sec.
S-60	1/5 sec.	60 min.	±.1 sec.
SM-60	1/100 min.	60 min.	±.002 min.
S-10	1/10 sec.	1000 sec.	±.02 sec.
S-6	1/1000 min.	10 min.	±.0002 min.
S-1	1/100 sec.	60 sec.	±.01 sec.
MST-100	1/1000 sec.	6 sec.	±.001 sec.
MST-500	1/1000 sec.	30 sec.	±.002 sec.

STANDARD ELECTRIC TIME
DIVISION OF JOHNSON SERVICE COMPANY



89 LOGAN STREET, SPRINGFIELD, MASSACHUSETTS 01101

Circle 150 on Reader Service Card

areas, it may be necessary to install one or more satellite receivers about town which are in turn connected to the studio by leased lines. When satellite receivers are used, their audio outputs should not be combined. The output of the receiver delivering the best signal can be selected manually at the studio or by a "voting circuit," as illustrated in Fig. 8. The voting circuit (commercially available) compares the S/N of the two receivers and passes the best of the two signals to the studio.

The portable transceivers should preferably be of the type which will accept an external microphone. Two or more microphones can be used by providing a portable audio mixer connected to the transceiver microphone jack.

To boost power, use an RF power amp

For maximum flexibility, vehicles can be equipped with an RF power amplifier and a roof-top antenna. A hand-held portable transceiver plugs into the RF power amplifier assembly to form a relatively high power mobile unit. When it is necessary for the announcer or news man to leave the vehicle, the transceiver is removed and is used as a portable unit (see Fig. 9.).

Portable transceivers and scanner receivers are available from several manufacturers. Local sources of such equipment can be found in the telephone directory yellow pages under "Radio Communication Equipment and Service." **BM/E**

TV Studio SALE



STUDIO SOUND BOOM — M-R w/perambulator. Regular \$2,800. Sale price, \$1,250.



TV STUDIO SPECIAL: Famous **ACADEMY CRANES** in excellent condition at a bargain price of \$3,500! Save \$8,500!

CINE SCOOPS — 1500-watt capacity. Regular \$50. Sale price \$15 while they last.

BIRNS & SAWYER, INC.

1026 NORTH HIGHLAND AVENUE
LOS ANGELES, CALIFORNIA 90038 • (213) 466-8211

Circle 152 on Reader Service Card

**how to
Deliver an
FM SIGNAL
with**

SOCK!

It's easy to do. Not too expensive either. Good stereo demands low VSWR. Our circular polarized "Penetrator" antenna guarantees a VSWR of 1.1 to 1 before it's even mounted. And after installation it may be field trimmed to reproduce a VSWR value of 1.08 to 1. This provides a superior stereo signal.

The "Penetrator" will also increase your audience by penetrating difficult areas and by reaching more car receivers and small portables. It's the only circularized FM antenna with variable horizontal-to-vertical gain ratios. It delivers a signal with sock!

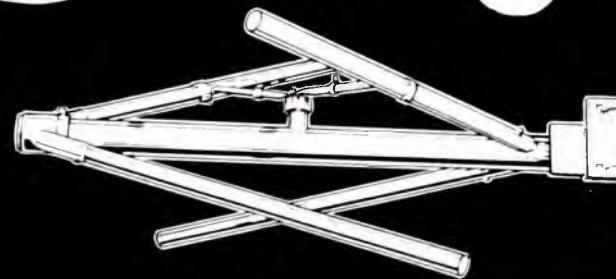

JAMPRO ANTENNA COMPANY
A DIVISION OF COMPUTER EQUIPMENT CORPORATION
PHONE (916) 383-1177
6939 Power Inn Road • Sacramento, CA 95828

Circle 151 on Reader Service Card

www.americanradiohistory.com

BM/E CLASSIFIED MARKETPLACE

CLASSIFIED ADVERTISING RATES

DISPLAY CLASSIFIED ADVERTISING: \$22.50 per inch 1x; \$22.00 per inch 3x; \$21.00 per inch 6x; \$20.00 per inch 12x. ALL OTHER CLASSIFIED ADVERTISING 25¢ per word; minimum \$3.00. BLIND BOX NUMBER: No extra charge. Replies sent to address below will be forwarded to you. PAYABLE IN ADVANCE; send check with order. CLOSING DATE: 5th of 2nd month preceding issue date.

BM/E, Monterey and Pinola Avenues, Blue Ridge Summit, Pa. 17214

Phone 717/794/2191

HELP WANTED

FIELD SERVICE ENGINEERS

The leading manufacturer of videotape recorders and television color cameras is looking for field service engineers for our regional offices in New York, Chicago and Atlanta.

Previous field maintenance on videotape recorders and television color cameras experience required. Broadcast television experience desirable.

For immediate consideration, please write outlining your experience to the regional office nearest you: Al Jones, Field Service Supervisor, 690 N. Broadway, White Plains, N. Y. 10603, (914) 761-7820; R. Hickman, Field Service Supervisor, 35 Executive Park Dr., N. E., Atlanta, Ga. 30329, (404) 633-1462; or C. M. Nowell, Field Service Supervisor, 1920 Waukegan Road, Glenview, Ill. 60025, (312) 729-5160. We are an equal opportunity employer.



TELEVISION ENGINEER

University of Tennessee currently has a job position open as Engineer in the Television Services Department. This is a maintenance position and the desired individual should have strong experience in quadruplex and helical scan VTR machine. The required individual should have three to five years experience in video and audio maintenance of television equipment. Position is available immediately.

Reply to:
University of Tennessee
Television Services Department
1345 Circle Park Drive
Suite #40
Knoxville, Tenn. 37916
Phone: (615) 974-5272

ATTN: David L. Bower, Chief Engineer

NEED IMMEDIATELY. Systems Techs with at least 5 years experience with 1200's, TR 70's, AVR 1's, Cameras (Broadcast Color), HS 100's, and 200's in Chicago area. Positions are with an international production house. Full benefits and salary commensurate with experience. Please send a resume to: Editel Productions, Inc., 1920 Lincoln Ave., Chicago, Ill. 60614.

ENGINEERING OPPORTUNITIES. One of the nation's leading public television and radio Production Centers offers challenging engineering career openings. Candidates must be technically qualified and fully capable of quality production and state-of-the-art techniques. Send resume to: Bonnie Wells, WGBH-TV, 125 Western Ave., Boston, Mass. 02134.

DESIGN ENGINEER. TV Broadcast design engineer, BSFE or equivalent. Five years experience—all phases network broadcasting. Digital design also required. Send resume to: Public Broadcasting Service, 485 L'Enfant Plaza, S. W., Washington, D.C. 20024. ATTN: R. D. McCormick

STAFF ENGINEER. Experienced in design and construction of television broadcast systems, including studio and transmitter equipment. Send resume to: Chief Engineer, S. C. Educational Television Center, Drawer 1, Columbia, S.C. 29250. An Equal Opportunity Employer.

POSITIONS WANTED

RADIO-TV CHIEF ENGINEER experienced in commercial and educational systems design, operation and maintenance. First phone. Reply to Box 173-1, BME, Blue Ridge Summit, Pa. 17214.

EQUIPMENT FOR SALE

FOR SALE

1—RCA TTU12A Transmitter. On Channel 33. Just can be returned for other frequencies.

INCLUDING:
1—TTU 1B Driver
2—12 KW Power Amplifiers with Power Supply
1—Filterplexer
1—Heat Exchanger with spare water coil
1—Set of Spare Cavities for all stages
1—Set of Miscellaneous Parts and Tubes

This transmitter is currently in operation and will be available in January 1973.
600 ft. 6 1/2" EA Bolt Flange Type Transmission Line. Used and in Good condition.

Contact:
A. W. Taylor
WYTV, Inc.
Youngstown, Ohio
Phone: (216) 783-2930

SEC CUSTOM AUDIO CONSOLES at prices comparable to other manufacturers' standard units. Modern styling with vertical slide potentiometers and "soft" audio switching. Completely assembled or save even more on console kit. Call or write for custom quotation. Also plug-in audio modules; distribution amplifiers, pre-amplifiers; active combining networks, monitor amplifiers. Write or call for brochure.
SYSTEMS ENGINEERING COMPANY, P. O. Box 49224, Atlanta, Georgia 30329, 404 631-3586.

AMPEX 300, 350, 352, 400, 450 users, for greater S/N ratio, replace first playback stage 128J7 with our plug-in transistor preamp. For specification write VIF INTERNATIONAL, PO Box 1555, www.americanradiohistory.com

EQUIPMENT FOR SALE (Cont'd)

AMPEX VR-7800-C

One inch Video Tape Recorder with full color electronic editor, processing amplifier, used for 180 hours and in like new condition. Cost: \$16,200. Selling Price is \$10,000.

FOB:

Applied Video Electronics, Inc.
P. O. Box 25, Brunswick, Ohio 44212

CARTRIDGE TAPE EQUIPMENT—Rebuilt. New paint, heads, flywheel, pressure roller, belts etc. Spotlessly clean and thoroughly tested. 30 day money-back guarantee, 90 day warranty. Also contact us for possible discounts on new equipment and accessories.

AUTODYNE, Box 1004,
Rockville, Maryland 20850
(301/762-7626).

MOTORS FOR SPOTMASTERS

NEW Papst hysteresis synchronous motor HSZ 20.50-4-470D as used in series 400 and 500 machines. Price \$39.00 each prepaid while they last. 90 day warranty. Terms check with order only, no COD's. Not recommended for Tapecaster series 600 or 700.

TAPECASTER TCM, INC., Box 662
Rockville, Maryland 20851

SCULLY TAPE RECORDERS: Mono, 2, 4, 8, 12, & 16 track models plus 270 automatic players. Some models in stock now. W.A.L. custom audio control console & console modules. Solid state 120 Watt power Amps. We buy and rebuild Scully lathes, WIFGAND AUDIO LABORATORIES, INC. R.D. 3, Middleburg, Pa. 17842, 717-837-1444.

Solid-state audio modules-console kits, power amplifier kits, power supplies. Octal plug-ins—mic, eq, line, disc, tape play, tape record, amplifiers. Audio & tape bias oscillators. Over 50 audio products. Send for free catalog and applicators. Opamp Labs, Inc., 172 So. Alta Vista Blvd., Los Angeles, Calif. 90036. (213) 934-3566.

RCA, GE COLOR encoders, RCA, GE color and monochrome cameras, GE TT-25, 12.5 KW, UHF Transmitter, all priced to sell. TK-26 color Film chain, also new ADC audio patch panels. Write for list. Goldberg, 1618 James, Syracuse, N.Y. 13203. (315) 479-7620, 478-0046, 463-4567.

Power system portable for remote TRAILER or VAN. TORAIN INVERTER supplies 110 VAC for emergency TV operation from batteries. Rectifier recharges batteries. NEW—\$1955.00. SAI E PRICE—\$1250.00. Tele-Measurements, Inc., 145 Main Ave., Clifton, N.J. (201) 473-8822. Contact J. R. Popple.

FIFID STRENGTH METER. 540 KHz to 5MHz. Ten microvolts to 10 volts per meter. New solid state design, long battery life. Stable accurate calibration. Free literature. Solar Electronics, 901 No. Highland Ave., Hollywood, Cal. 90038.

AMERICA'S LARGEST STOCK AND COMMISSIONMENT LISTING of new and used broadcast and recording equipment. We trade-sell and buy. THE MAZE CORPORATION, P.O. Box 6636, Birmingham, Ala. 35210.

SPARTA 600-CRP and 600-CP-RK Stereo cart-ridge. Playba k and recorder both with 150 Hz and 8 KHz Aux Cue. One year old in excellent condition. K7ST-FM, Box 2755, Santa Rosa, Calif. 95405. Phone: (707) 528-4434.

The complete and reliable source for new and used broadcast equipment. Request our free listings. Broadcast Equipment and Supply Co., Box 3141, Bristol, Tennessee 37620

4—650 ft. towers \$6500.00 each. Many more. Ground wire 85¢ per x lb. Bill Angle, Box 55, Greenville, N.C. 27834. Tel. 919-752-3040.

RCA VIDEO RECORDERS TR22 low-band color and mono. Also, TR-3 mono player. Broadcast Equipment Service, Box 2989, Bon Air, Va. 23235 (703) 272-0693.

Two RCA-TK-42 color camera chains complete with auxiliary electronics and controls. \$15,000 each. E. Newton Wray, General Manager, K7BS-TV, Shreveport, La. 71104. Phone (713) 429-3644.

CLASSIFIED continued

EQUIPMENT FOR SALE (cont'd)

McMartin TBM-3500 Modulation monitor and TBN 3000 frequency monitor. Both in excellent condition. Contact: WMOA-FM, Marietta, Ohio. (614) 373-1490.

MICA AND VACUUM transmitting capacitors. Large stock; immediate delivery. Price lists on request. SURCOM ASSOCIATES, 1147 Venice Blvd., Los Angeles, Cal. 90015 (213) 382-6985.

Presto 6N Lathe, 112,224 O. I. feedscrews, 1D cutter, 92B amplifier. A1 condition. Meissner Lab. 4630 NW Woodside Terrace, Portland, Ore. 97210. Phone 228-2553.

GATES FM EXCITER Model M5534. Good condition. Selling one of our spares. WTJU, Station #1, Charlottesville, VA. 22904. (703) 977-7734.

One stop for all your professional audio requirements. Bottom line oriented. F.T.C. Brewer, Box 8057, Pensacola, Fla. 32505.

B & H Videotape. 1/2" x 2400". List \$39.95. 54% off. \$18.50. AGE, Inc. 5362 Cahuenga Street, North Hollywood, Calif.

Surplus Audio Patch Panels All Standard Configurations. Gulf Telephone & Electronics, Inc. 6235 Beverly Hill, Houston, Texas 77027.

AMPEX 7500 Color Video Tape Recorder—mint condition—complete, \$1,200. Stan Nazimek, Jr. 506 Mount Prospect Ave., Clifton, N.J. 07012.

FOR SALE—2—PC-70's complete color camera chain, 3 years old. Best offer. Box 173-2, BME. Blue Ridge Summit, Pa. 17214.

FM Transmitter. Westinghouse FM-1. 1 KW. Now on 91.5 MHz. Best Offer. Contact Fred McWilliams. WDUQ, Duquesne University, Pittsburgh, PA. 15219. (412) 434-6024.

EQUIPMENT WANTED

TRANSCRIPTION DISCS of old radio and music. Any size, speed. Send full details and price to KINER, Box 1274, Bellevue, Wash. 98009.

TECHNICAL SERVICES

CUSTOM CARTRIDGE RELOADING and refurbishing. Fidelipac replacement parts and cartridges. Write us today for prices. PROFESSIONAL AUDIO SERVICES, BOX 1953, FT. WORTH, TEX. 76101.

Don't be an audio dropout in your market area. Our CARTRIDGE REWINDING SERVICE is back! BROADCAST EQUIPMENT REBUILDERS, Box 476, Windsor, Colo. 80550.

BUSINESS OPPORTUNITIES

RADIO STATION FOR SALE—5000 Watt AM . . . Eastern Arizona . . . \$175,000 . . . Substantial Cash . . . Harold Bruzee, KHIL, Willcox, Ariz.

INSTRUCTIONS

FCC FIRST CLASS RADIOTELEPHONE LICENSE IN SIX WEEKS. Classes in El Paso, Dallas, Atlanta, Chicago, Cincinnati, Denver, Ft. Worth, Hartford, Houston, Memphis, Miami Beach, Milwaukee, Minneapolis, Nashville, New Orleans, Oklahoma City, St. Louis, San Antonio, San Francisco, and Seattle. For information contact Elkins Institute, 2727 Inwood Rd., Dallas, Tex. 75235 214/357-4001.

First phone through tape recorded lessons at home plus one week personal instruction in Washington, D.C., Atlanta, Boston, Detroit, New Orleans, Minneapolis, Seattle, Denver, Portland, Los Angeles. Proven results. Our 17th year teaching FCC license courses. Bob Johnson Broadcast License Training, 1060D Duncan, Manhattan Beach, Calif. 90266. 213-379-4461.

ATTENTION VETERANS! First class license in five weeks with complete theory and R.C.A.-equipped laboratory training. Approved for veterans Tuition \$333.00. Housing cost \$16.00 per week. American Institute of Radio, 2622 Old Lebanon Road, Nashville, Tenn. 37214. 615-889-0469.

PROGRAM SERVICES

TAPES FOR AUTOMATION



THE CnB STUDIOS
Specializing in Custom Services

3415 BERESFORD AVENUE
BELMONT, CALIFORNIA 94002
415 / 592-6149

PROGRAM SERVICES (cont'd)

"Free" Catalog . . . Everything for the deejay! Comedy, books, airchecks, wild tracks, old radio shows, and more! Write: Command, Box 26348-A, San Francisco 94126.

CONSULTANTS

COHEN & DIPPELL
CONSULTING ENGINEERS
Formerly GEO. C. DAVIS
527 Munsey Bldg.
(202) 783-0111
Washington, D. C. 20004
Member AFCEE

JANSKY & BAILEY

TeleCommunications Consulting
Department
CATV & CCTV
Phone 703/354-3400-ext. 722 or 2400
Shirley Hiway at Edsall Road
Alexandria, Virginia 22314
Atlantic Research Corporation

BROADCAST STUDIO DESIGN

*Control Systems, Facilities Planning,
Plant Layout & Manufacturing*

DYMA ENGINEERING, INC.
Route 1, Box 51, Taos, New Mexico 87571
Phone: 505/758-2686

RALPH E. EVANS ASSOCIATES

Consulting Radio Engineers
AM - FM - TV - CATV - ITFS
3500 North Sherman Blvd.

MILWAUKEE, WISCONSIN 53216

Phone: 414-442-4210

McCLANATHAN & ASSOCIATES

consulting engineers
Applications & Field Engineering
Turnkey Installations—Radio & TV
Domestic & Foreign
P.O. Box 750
Portland, Oregon 97207
Phone: 563/246-8000

VIR JAMES

CONSULTING RADIO ENGINEERS
Applications and Field Engineering
Computerized Frequency Surveys
345 Colorado Blvd.—80206
(303) 333-5562
DENVER, COLORADO
Member AFCEE

USE BM/E's CLASSIFIED MARKETPLACE TO REACH OVER 28,000 BROADCASTERS!

Please run my ad in BM/E's CLASSIFIED MARKETPLACE in your next:

- 12 issues 6 issues
 3 issues 1 issue

Name

Station or Co.

Address

City State

BM/E, Classified Advertising Department, Blue Ridge Summit, Pa. 17214.
717/794-2191. (Enclose check.)

ADVERTISERS' INDEX

Alma Engineering, Inc.	54
American Electronic Laboratories Inc.	38
Ampex Corporation	39
Belar Electronics Laboratory Inc.	51
Birns & Sawyer	57
Broadcast Electronics, Inc.	48, 51
Byron Color-Correct	13
CCA Electronics Corp.	10
CMX Systems	43
Canon U.S.A. Inc.	49
Central Dynamics Ltd.	53
Cohu Electronics Inc.	15
ColTape, A Div. of Columbia Pictures Industries, Inc.	17
Cosmicar Optical Co., Ltd.	53
Datatron Inc.	12
Delta Electronics Corp.	16
Dynair Electronics Corp.	3
Fidelipac Div. of Telepro Industries Inc.	55
Fort Worth Tower Co., Inc.	48
Frezolini Electronics Inc.	46
Gates Division, Harris	41
Grass Valley Group Co., Inc., The	5
Harvey Radio Co.	50
Heller-Oak Finance Corp.	CM/E-12
International Video Corp.	Cover 4
Jampro Antenna Corp.	57
Jerrold Electronics Corp.	CM/E-2
LPB Inc.	42
McMartin Industries Inc.	46, 51
Mediatech	18
3M Company, Mincom Div.	47
Palmer Films, Inc., W. A.	37
Rapid-Q	46
Richmond Hill Laboratories Inc.	32
Rowe International, Inc.	19, CM/E-9
Schafer Electronics Corp.	42
Shibaden Corporation of America	9
Shure Bros.	60
Sparta Electronic Corp.	7
Standard Electric Time Division of Johnson Service Co.	56
Systems Wire & Cable Inc.	CM/E-7
TapeAthon Corp.	CM/E12
Tektronix	11
Teledyne Camera Systems	Cover 2
Telemet Company	Cover 3
Television Equipment Associates	42
Television Microtime, Inc.	44
Telex Communications Division	40
Time & Frequency Technology Inc.	52
Video Data Systems, Inc.	56
Wilkinson Electronics Corp.	45

SALES OFFICES

Broadband Information Services, Inc.
274 Madison Avenue
New York, New York 10016

EASTERN STATES

274 Madison Avenue
New York, New York 10016
212-685-5320

Charles C. Horner

MIDWESTERN STATES

New York Office

WESTERN STATES

1111 Hearst Building
San Francisco, California 94130
415-362-8547

William J. Healey

16400 Ventura Blvd.
Encino, California 91316
213-981-4721

Art Mandell

JAPAN

Nippon Keisoku Inc.
P.O. Box 410
Central Tokyo, Japan
536-6614

Yoshi Yamamoto



it 's on record...



Now it's official! An association equipment survey quoted in *BM/E* magazine produced some very revealing information on FM broadcast industry preferences — particularly in the category of phono cartridge usage, where a whopping 57% of the respondents expressed their preference for Shure cartridges . . . *more than all other brands combined*. It didn't particularly surprise us because we know our M44 series with its uncommon combination of clear sound, low cost, exceptional ruggedness and excellent back-cuing characteristics, has been the broadcast standard for years. And our peerless V-15 Type II Improved? There simply isn't a better cartridge for "high fidelity" FM operations. Write for the free Shure "Guide to the Conversion of Monophonic Broadcast Facilities for Stereo Records," as well as the complete Shure Phono Cartridge Catalog.

Shure Brothers Inc.
222 Hartrey Ave., Evanston, Ill. 60204



Circle 153 on Reader Service Card

www.americanradiohistory.com

Now digital remote control of your transmitter is a fact...not a remote possibility.

Our Model RCS 100 is an all solid-state system that gives you full control and monitoring from the studio, with little effort and no errors. Selection of controls, with confirmation, is instantaneous. Access is random, not sequential. Parity checks and double scan provide high noise immunity. And direct digital readout requires no interpretation, with out-of-limit conditions capable of generating alarm signals.

Other features: If power is lost, works on non-interrupt basis from a 12-volt auto battery; interfaces with process control or mini computer to automate transmitter; operates under all transmitter environments; available in 15, 31, 47 or 63 selection capacity; built-in interface for optional Telemet Automatic Data Logger.

Digital remote control of your transmitter is here. For further details or a demonstration, contact: Telemet, Amityville, N.Y. 11701, (516) 541-3600.

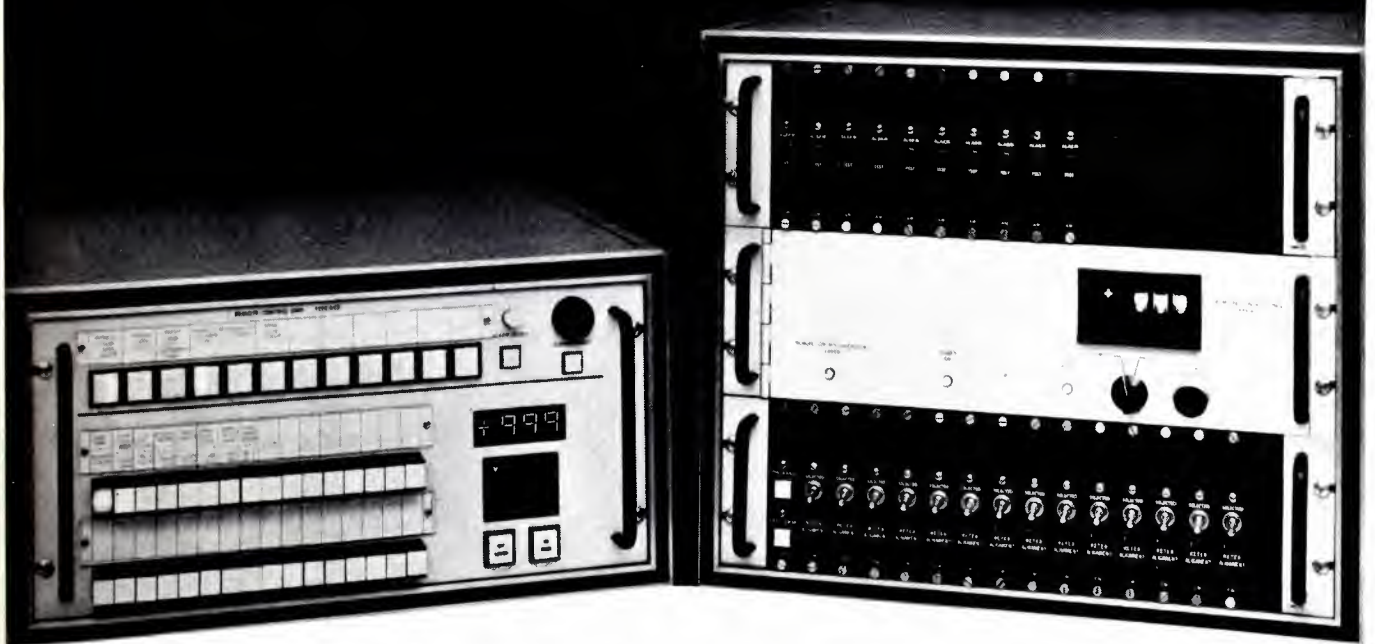

Better ideas for Broadcasting

Telemet A GEOTEL COMPANY

Amityville, New York 11701, (516) 541-3600

Manufactured for Telemet by Spantronics, Inc

REGIONAL OFFICES Chicago, Ill (312) 627-6026 Atlanta, Ga (404) 361-2951 Houston, Tex (713) 946-5796 Santa Ana, Calif (714) 540-6756

Circle 155 on Reader Service Card

www.americanradiohistory.com

